

Performance Validation and Energy Analysis of HVAC Systems using Simulation

Tim Salisbury and Rick Diamond

Indoor Environment Department
Lawrence Berkeley National Laboratory
Berkeley, California

Abstract

This paper describes the concept of using simulation as a tool for performance validation and energy analysis of HVAC systems. Recent advances in control system technology, including the development of open protocols such as BACnet™ have made sensor and control signal information from various components and subsystems in a building more accessible. This development has created significant potential for improving the monitoring and supervision of building systems in order to optimize operational performance. The paper describes one way of making use of this new technology by applying simulations, configured to represent optimum operation, to monitored data. The idea is to use simulation predictions as performance targets with which to compare monitored system outputs for performance validation and energy analysis. The paper presents results from applying the concepts to a large dual-duct air-handling unit installed in an office building in San Francisco.

1 Introduction

Significant potential exists with the current technology of energy management and control systems (EMCS) for monitoring and optimizing building systems during operation. More effort is spent typically on the design of a system and its construction/installation than on its operation. Operational optimization of building systems has traditionally attracted much less attention, and investments made in ensuring that the systems installed in a building are operating correctly are often relatively small. Several studies have highlighted operational problems and their potential impact on energy, maintenance, and comfort. Recent case studies (Herzog and LaVine, 1992; Claridge *et al.*, 1994) suggest that energy savings of between 15% and 40% could be made in commercial buildings by closer monitoring and supervision of energy-usage and related data. An earlier study by Kao and Pierce (1983) showed that sensor faults could lead to similar levels of energy wastage, in addition to disrupting comfort conditions.

The improvements in the monitoring and supervision capabilities of EMCSs have served to make operational problems more visible and quantifiable to the industry. An increased awareness in the industry of the possible benefits from optimizing operations has consequently led to several national and international research projects in this area. In particular, the International Energy Agency (IEA) has sponsored two efforts in this area: Annex 25 (Hyvärinen and Kärki, 1996) and, more recently, Annex 34. These projects have been largely concerned with developing and applying performance evaluation and

fault diagnosis methods to the data available on EMCS networks. Other efforts have employed similar techniques to validate operational performance at the commissioning phase of a building (Haves *et al.*, 1996a).

One element that is common to many of the methods proposed for fault diagnosis and performance evaluation is the use of a system model. The majority of methods use a model of some sort, either explicitly or implicitly, to detect changes in system behavior. A model may be developed empirically from input and output data sets (training data) (Lee *et al.*, 1996), from rules (Dexter and Benouarets, 1995), or from physical system information (Haves *et al.*, 1996b). In practice, the amount of training data required to identify empirical models reliably may be prohibitive due to time constraints and limitations in exercising systems across their operating ranges at certain times of the year. Collecting expert knowledge to initialize detailed rule-based methods can also be difficult in practice and these models often need supplementing with some physical system information (Dexter and Benouarets, 1996).

The use of models configured from physical system information can be a more viable approach, if the information can be obtained easily and is representative of the considered system. Simulation software that uses models configurable from physical system information has been evolving steadily over recent years. HVAC component and subsystem models are now generally well understood and have been the subject of a number of validation tests (e.g., Clark *et al.*, 1985; Park and Bushby, 1989; Ding *et al.*, 1990; Ljungkrona *et al.*, 1992). Although simulation has traditionally been a design tool, the opportunity now exists to extend its use to other life-cycle processes such as operations.

This paper describes the application of simulation-based validation to a large dual-duct air-handling unit installed in a large office building in San Francisco. The paper describes the models used in the simulation and presents results from using data collected over a one-year period. The configuration requirements of the simulation models described in the paper are compatible with data model standards currently under development in the International Alliance for Interoperability (IAI). One project within the IAI is concentrating on the development of data models for HVAC subsystems, and air-handling units are one subsystem under consideration.

2 Simulation-Based Validation Methodology

The concept of using simulation for performance validation is analogous to model-based fault detection. The idea is to compare the behavior of a model with the observed behavior of a real system. A simulation contains a number of different models that are linked together to represent a complex system. Individual models within a simulation may wholly interact with other models, or they may derive some of their inputs or outputs externally.

Figure 1 shows one way of using simulation for performance validation. In this example, the idea is to configure the simulation to represent the real system in its correctly

operating (optimum) mode of operation. Measured inputs to the system under observation are used as inputs to the simulation, which then makes predictions of the same variables designated as system outputs. As the simulation represents the correctly operating system, differences between output predictions and measurements will be indicative of incorrect or sub-optimal operation.

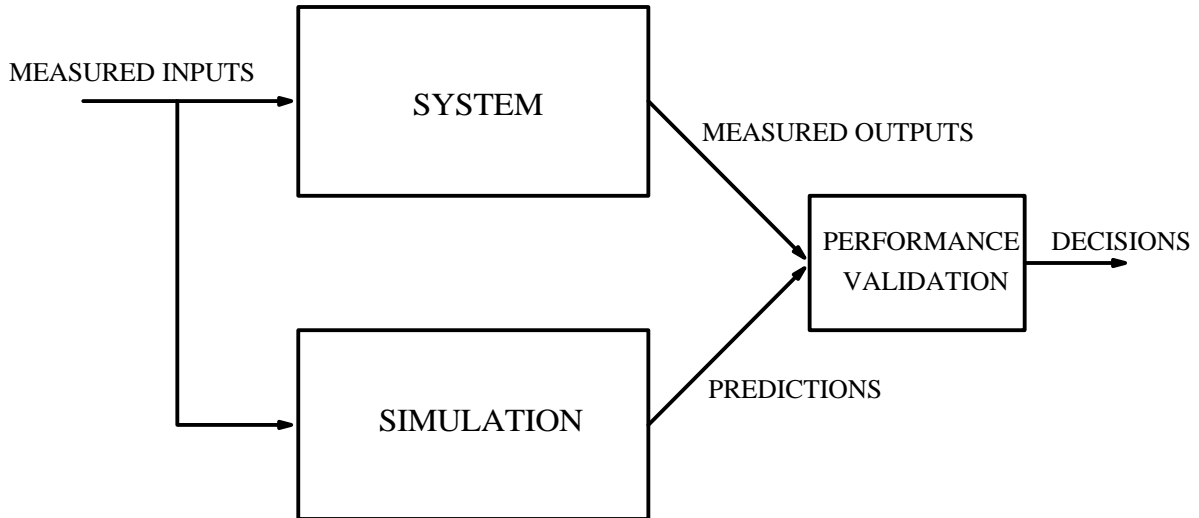

Figure 1: Performance validation methodology.

According to a general fault detection and diagnosis framework developed by Rossi and Braun (1993), the performance validation box in Figure 1 would represent a “classifier”. The classifier would contain diagnostic logic to determine the cause of any differences between measurements and predictions and decide what action to take. There are numerous techniques capable of carrying out these functions, such as: expert rules, neural networks, fault trees, etc. Instead of attempting to automate the classification task, this paper describes a different conceptual approach where the simulation acts as a “virtual system”. The idea is to make this virtual system available to operators so that they may interrogate it in the same way as they would the real system. The main difference between performance validation, in this context, and a fully automated fault detection and diagnosis scheme is that the simulation represents the idealized behavior of the system. In practice, “ideal” operation may be unachievable in the real system; the simulation therefore acts as a performance reference, rather than a definite realizable target.

2.1 Usage Scenario

Modern EMCSs have graphical user interfaces that allow the display of real-time sensor and control signals alongside schematic diagrams of the system. In addition, most systems have the facility to produce trend plots of particular variables or derived quantities. Although techniques for characterizing and visualizing system performance are evolving (Austin, 1997), operators lack a means by which to assess whether the system is actually performing as it should.

A simulation configured from design information and based on the use of idealized models will predict ideal, or optimum, behavior, which may act as a reference or performance target. Ideally, simulation would run as a process on the control system network, so that simulation predictions would be available to building operators in addition to the monitored values. In effect, the simulation would represent a virtual system running in parallel to the real system. It would then be possible to apply any analysis technique to both the real and simulated data so that performance references are available at each level of system interrogation. Examples of derived quantities that would be particularly useful for performance assessments are the energy use of different HVAC subsystems, control loop errors, etc.

3 Description of Test System

Figure 2 shows the dual-duct air-handling unit used to demonstrate the potential of using simulation as a performance validation tool. In the unit, control dampers, incorporating an economizer, mix return-air from the building with outside-air in order to maintain a fixed mixed-air temperature setpoint. A large supply fan blows the mixed-air through both the hot- and cold-deck ducts. The control of the supply fan maintains the average of the hot and cold ducts at a fixed static pressure setpoint. The supply fan speed varies in order to counteract changes in duct system resistance brought about by dampers opening and closing in VAV terminal units. Two fans installed in the return duct have their speeds tracked to the speed of the supply fan. The hot and cold ducts each house a heat exchanger with controllers configured to maintain fixed setpoints by modulating control valves. The hot duct heat exchanger has a two-port valve and the cold duct a three-port valve. The air-handling unit has the capacity to deliver 74kg/s of air and provide 850kW of heating and 1260kW of cooling.

A relatively small number of sensors were used in the evaluation and these are indicated in Figure 2 as boxes containing either a “T”, meaning temperature, or an “H”, meaning relative humidity. “P” denotes a static pressure sensor, and these were used in the fan control loop but not in the performance evaluation. The sensors were installed specifically to facilitate energy analysis; however, they replicate the EMCS sensors and represent a reasonably standard level of instrumentation for equipment of this type.

The building in which the air-handling unit is installed is located in central San Francisco and has recently been the subject of a major demonstration of the BACnet communication protocol (ASHRAE, 1995). Retrofits in the building have led to the upgrading of several control-systems to include BACnet compliant devices allowing interoperability between products from different manufacturers.

A recent analysis (Diamond *et al.*, 1998) showed that the enhancements made to the control system have resulted in significantly improved potential for operator supervision of the HVAC devices. In particular, operators indicated that they felt better able to interrogate the system and locate problems in response to complaints from building occupants. However, the analysis also revealed that the EMCS was not being used to its full potential. The main concern of operators was to maintain occupant satisfaction; the

performance of the system in terms of energy and maintenance was less important. Availability of performance targets may help to improve operator supervision in these respects. In all but the severest cases, the operators were not aware when the system was operating sub-optimally.

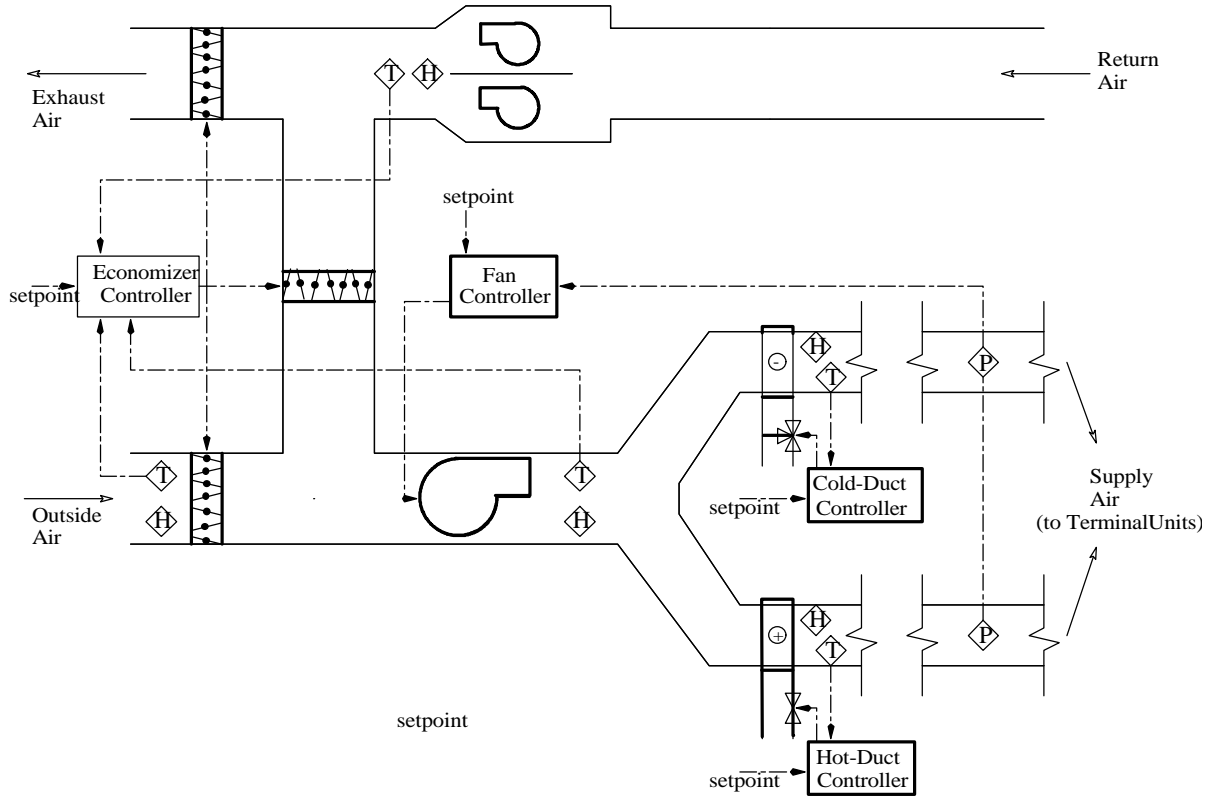

Figure 2: Schematic of the dual-duct air-handling unit.

3.1 Control Strategies

The temperature control strategy for the air-handling unit, described below, is the strategy that was effective during the period covered by the monitored data used in the analyses. Note that the setpoints for the heating, cooling, and mixing subsystems are not scheduled. At the time of writing this paper (November, 1998), there were plans for several further enhancements to the control strategy, including setpoint scheduling, night setback, and optimal start and stop.

- Economizer:
 - dampers modulated to maintain 12.8°C when fans are running
 - movement direction of dampers determined by a temperature economizer
 - a minimum fraction of outside air is ensured by limiting damper ranges
- Cooling coil:
 - chilled-water valve modulated to maintain a setpoint of 13.3°C
- Heating coil:
 - steam-heating valve modulated to maintain a setpoint of 33.3°C

- Warm-up mode (instigated for return air temperatures below 15.6°C):
 - chilled-water valve closed
 - economizer operated to provide 100% return air
 - hot-deck temperature setpoint changed to 37.8 °C

The fan control-loop regulated the variable-frequency drives in order to maintain the average of the hot- and cold-deck static pressures to a setpoint of 249 Pa. A high limit was set on the static pressure of 1992 Pa, at which point the fans would cease to operate. During the warm-up period, the controller modulated the fans to maintain 249 Pa in the hot deck only. All local-loops in the control strategy used PI algorithms for modulation.

4 Description of Simulation

The MATLAB programming environment was used to develop a simulation of the dual-duct air-handling unit. The simulation comprised several subsystem models, interconnected in a similar fashion to the real components. Figure 3 shows a block diagram of the simulation. A modular framework formed the basis of the simulation model development whereby each specific model was a self-contained object derived from a generic class-type. The configuration data of each model were determined according to standards under development IAI.

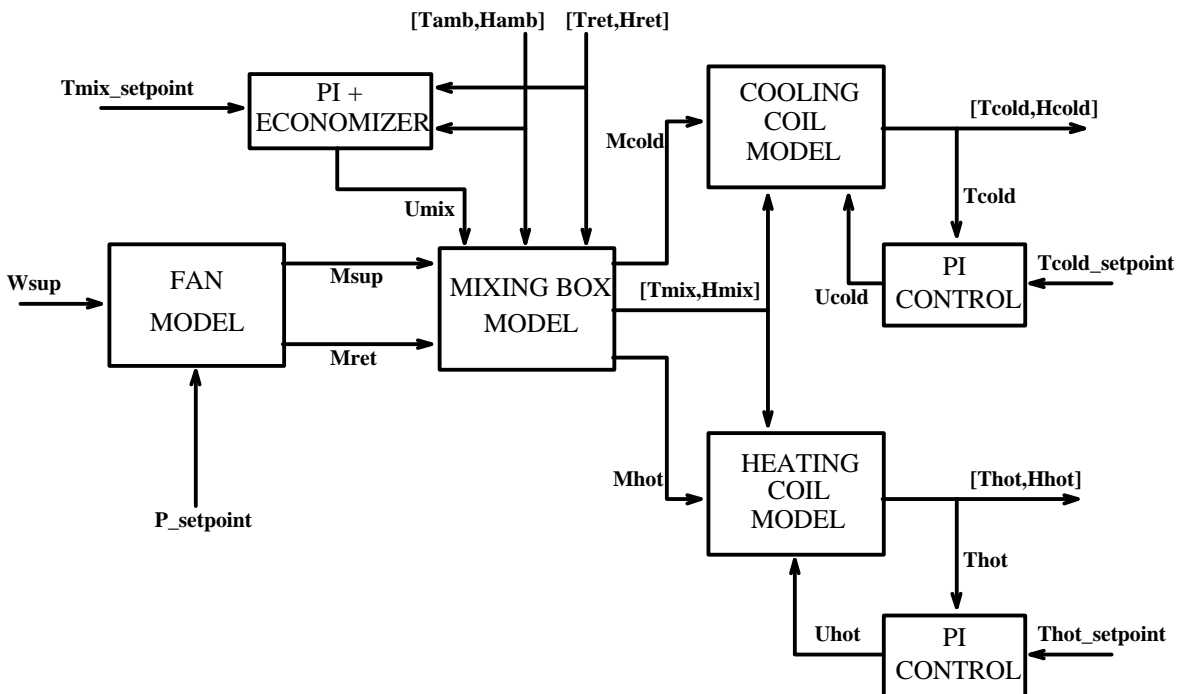

Figure 3: Block diagram of simulated dual-duct air-handling unit.

4.1 Boundary Conditions

Selection of which monitored inputs to drive the models and which monitored outputs to use as comparison variables fundamentally affects the detail in which performance

validation may be carried out. The selected inputs and outputs define a boundary encompassing the treated subsystems and components. With the simulation configured to represent optimal operation, discrepancies between simulation predictions and monitored data indicate sub-optimal operation in the “system” within this boundary. In the example considered here, measurements of the control-signals to the coil and mixing box subsystems were not available. The simulation thus included the local-loop controllers in order to predict the control signals, based on monitored setpoints. Hence, de-coupling of controller and subsystem performance is difficult without additional information.

One limitation of modeling the local-loop controllers in the simulation rather than using monitored control signals is that changes in the relationship between control signals and output capacities of the different subsystems are not easily detected. Problems that fall under this category are heat exchanger fouling, sensor drift, valve/damper leakage, etc. However, it becomes possible to detect these problems when changes in subsystem capacities cause setpoints to be unattainable. Certain subsystem problems thus become more evident when control signals saturate at their upper or lower limits. Control signal saturation therefore effectively de-couples the controller from the observed process.

4.2 Component and Subsystem Models

The models used in the simulation were adapted from static component model functions used in the simulation programs HVACSIM+ (Clark, 1985) and TRNSYS (e.g. Fiscal *et al.*, 1995). Object specifications for air-handling units, currently under development in the IAI, formed the basis of the model data structures. All data elements required to configure the simulation are currently being included in *version 3* of the IFC specifications.

4.3 Controllers

PI algorithms were used to control the heating and cooling coils and the mixing-box in the simulation. The velocity form of the PI algorithm was used to simplify protection against integral wind-up. The mixing-box controller also incorporated a temperature-based economizer to determine the direction in which to move the dampers. The sequences of operations were set up in the simulation according to the schedule described in Section 3.1. The Ziegler-Nichols open-loop method was used to tune the controllers, based on information obtained from regions of highest gain for each controlled subsystem.

4.4 Dynamics

Digital filters were used to produce dynamic behavior in the simulation, as illustrated in Figure 4.

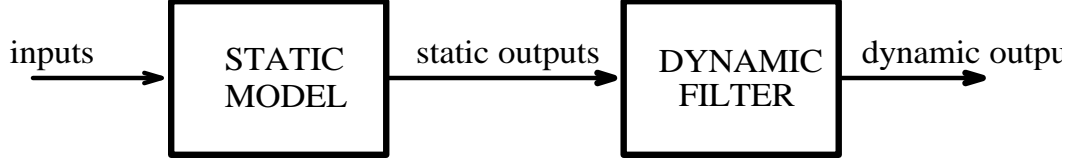

Figure 4: Method of incorporating dynamics in the simulation models.

Filters were applied to outputs at the subsystem model level to minimize the number of parameters. Adoption of this approach meant that the dynamics of the constituent components were effectively lumped together. First-order filters were applied to the fans, while second-order filters were applied to the coil subsystem and mixing-box models. The fans thus required just one time constant parameter, while each coil subsystem and mixing-box model required two time constants. Time constant estimates were not tuned for the considered system, default values were used obtained from tests of typical behavior (e.g., Buswell *et al.*, 1997).

4.5 Solution of Simulation Equations

The static model functions for the fan and heat exchanger (in cooling mode only) required iteration to obtain solutions for a given set of inputs. In these cases, the Newton-Raphson method was used to find a solution based on a convergence tolerance set equal to the machine precision. It was possible to solve all other static functions in the simulation without iteration. Euler integration was used to find a solution for the dynamic equations as shown below.

$$\text{FIRST-ORDER:} \quad y(t + \Delta t) = \left(1 - \frac{\Delta t}{\mathbf{t}}\right)y(t) + \frac{\Delta t}{\mathbf{t}}u(t) \quad (1)$$

$$\text{SECOND-ORDER:} \quad v(t + \Delta t) = v(t) + \frac{\Delta t}{\mathbf{t}_1\mathbf{t}_2} [u(t) - y(t) - (\mathbf{t}_1 + \mathbf{t}_2)v(t)] \quad (2)$$

$$y(t + \Delta t) = y(t) + \Delta tv(t) \quad (3)$$

where \mathbf{t} is the time constant for the first-order equations, and \mathbf{t}_1 and \mathbf{t}_2 are time constants for the second-order equations, $u(t)$ is a scalar output of the static model, $y(t)$ is the dynamic output, and $v(t)$ is an auxiliary variable. The integration time-step (\mathbf{Dt}) was determined so that it was a sub-multiple of the sampling period of the monitored data and was a maximum of one tenth of the smallest time constant.

5 Results

Data were available for the considered air-handling unit covering a period of three years, from 1995 to 1998. The evaluation involved using simulation to validate performance during normal operation periods and to detect operational disruptions during one of these years (1997).

5.1 Performance Indices

Only design and commissioning data from the considered building were used to configure the simulation. Operational measurements of system inputs and outputs were not used to tune the simulation. The objective was therefore to determine whether a simulation of this sort could form the basis of a diagnostic tool in the sense of providing performance targets.

The simulation used measurements of temperature and relative humidity in the real system as inputs to the subsystem models. In order to assess performance, indices related to energy transfer were calculated. Changes in enthalpy and the airflow rate predicted by the fan model in the simulation were used to calculate heat-transfer rates for the three main subsystems in the air-handling unit:

$$P_r = (h_{in} - h_{out})\hat{m} \quad (4)$$

$$P_s = (h_{in} - \hat{h}_{out})\hat{m} \quad (5)$$

where P_r and P_s are heat-transfer rate estimates for the real and simulated subsystems respectively, h_{in} and h_{out} are the inlet and outlet enthalpies associated with a subsystem and \hat{m} is the air flow rate predicted by the fan model. Note that the *measured* inlet enthalpy and *predicted* outlet enthalpy were used to calculate the power for each subsystem in the simulated system.

5.2 Normal Operation

Typical daily profiles of the heat-transfer rates in each of the subsystems are shown in Figure 5 for the cooling coil, Figure 6 for the heating coil, and Figure 7 for the mixing-box. In each graph, the simulation predictions are shown as solid lines while the system heat-transfer rates are denoted by dashed lines. The x-axis shows the 24-hour time during each day. Selection of the days represented by each profile was arbitrary from data gathered during 1997. The cooling coil profile is for a day at the end of March, the heating coil profile for a day at the end of January, and the mixing-box profile is in the middle of April. Note that for the majority of the time, the mixing-box controller positioned the dampers to provide full outside air. Very few days showed damper movement, due to the temperate climate of San Francisco and the mixing-box controller setpoint of 12.8°C.

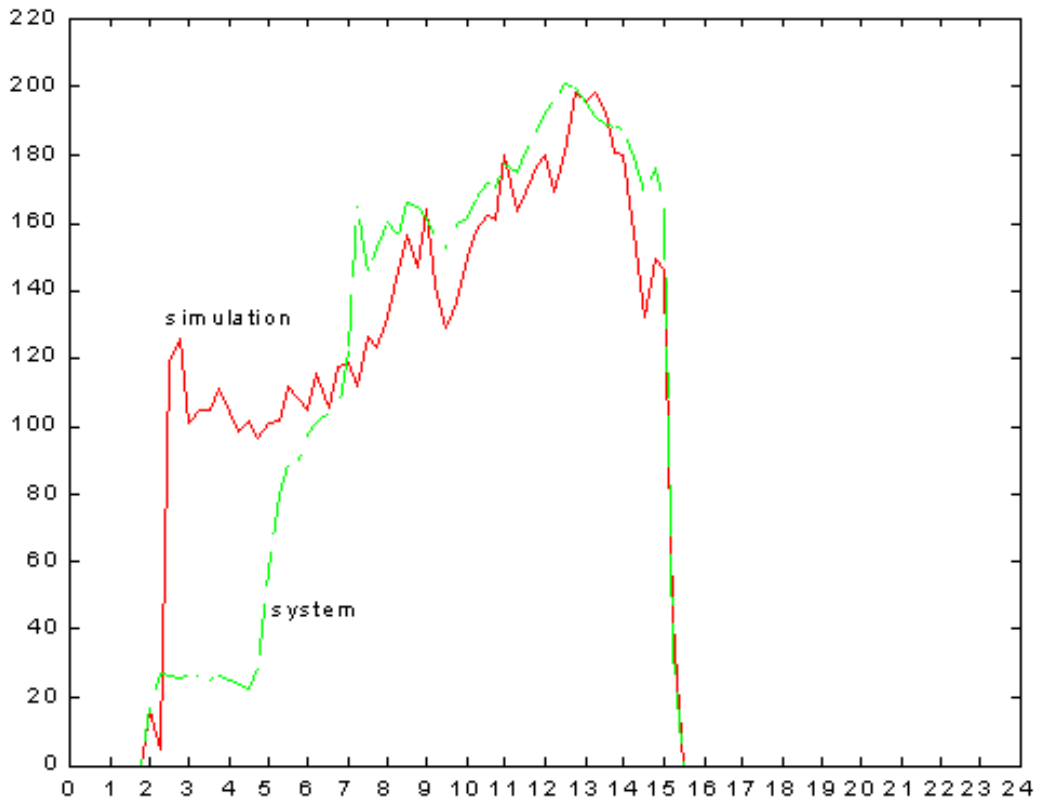

Figure 5: Heat-transfer rate day profile of the cooling coil subsystem.

Figure 5 shows that the biggest differences between the simulation and system occur in the first part of the day. There appears to have been a delay in the system before full activation of the cooling coil, and this was a consistent problem throughout the data. Examination of building procedures and operational schedules revealed that the cooling coil valve was manually isolated during the warm-up period of the building. The discrepancies between the simulation and system could therefore be due to delays in the operators activating the cooling valve. If the reason for the initial differences was that the cooling valve was isolated for too long, this also implies that the coil valve was leaking to some extent. The heat-transfer rate during the possible valve-isolation period was around one-fifth of the average cooling effect for the considered day. There was a good match between the simulation predictions and real data for the rest of the day.

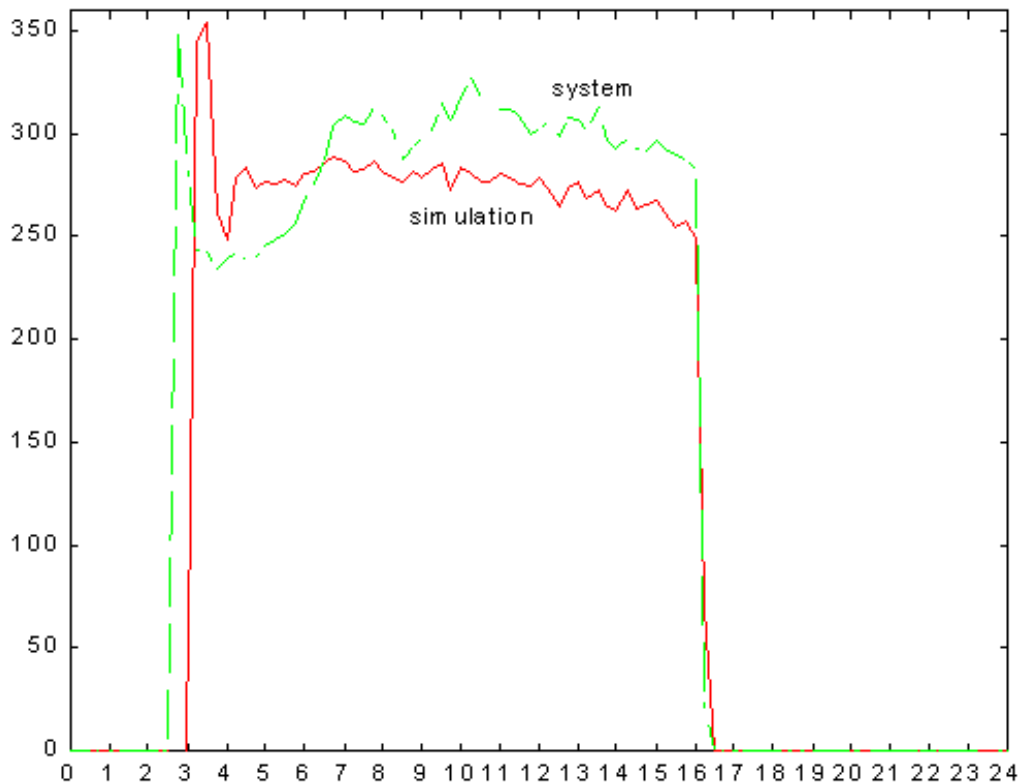

Figure 6: Heat-transfer rate day profile of the heating coil subsystem.

The heating coil performance matches the simulation more closely than did the cooling coil. Figure 6 shows that the initial transient response of the system is faster than that of the simulation. The reason for this is not clear, but it may have been due to an operator (or automated) override of the controller in the real system to force the valve to the fully open position immediately on start-up. The daily profile appears to be relatively flat in the simulation, whereas the system exhibits more load variation. This may have been due to poor (sluggish) control in the system evidenced by what appears to be a slow oscillation in the first half of the day, or an unmeasured disturbance.

The daily profile for the mixing-box in Figure 7 shows good consistency between simulation and system heat-transfer rates. Note that the absolute difference between the enthalpy of the outside air and mixed air was used to calculate the heat-transfer rate. The absolute value was used in order to account for the case when the dampers change direction due to the economizer controller. One feature to note is that before the dampers start to modulate (at 9 hours), the system shows a higher heat-transfer rate than the simulation. This is a persistent characteristic throughout the data and was probably due to return air leaking through the dampers even when the mixing-box was set to provide full outside air. Similarly, leakage through the outside air damper is evident during the latter half of the day, where the simulation predicts greater heat-transfer.

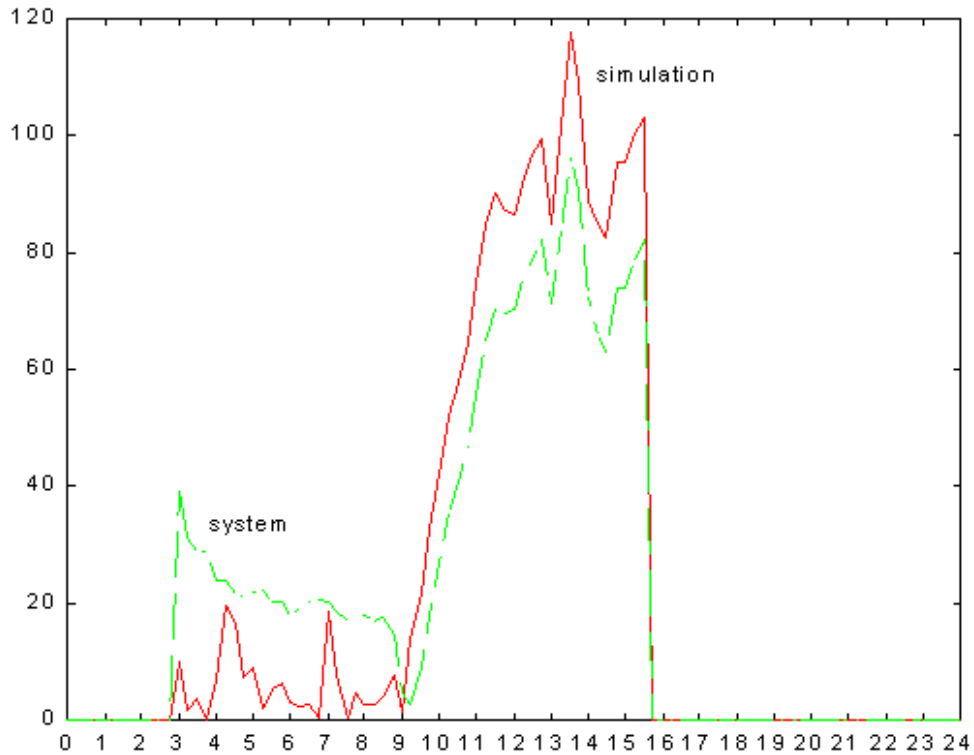

Figure 7: Heat-transfer rate day profile of the mixing-box subsystem.

5.3 Abnormal Operation

In this section, the simulation was used to detect periods of abnormal operation in the data. Detection was possible by contrasting the observed behavior with ideal behavior of the simulation.

Figure 8 shows a period during the operation of the heating coil where abnormal operation was apparent. The figure shows two daily profiles, one normal day and one abnormal. Note that the heat-transfer rate is fluctuating quite significantly in the system. There are two distinct periods in the abnormal day where the heat-transfer rate dropped to near zero. It is likely that the problem was due to disruptions in coil steam supply. These disruptions could have been the result of temporary interruptions in the boiler or pumping system operation.

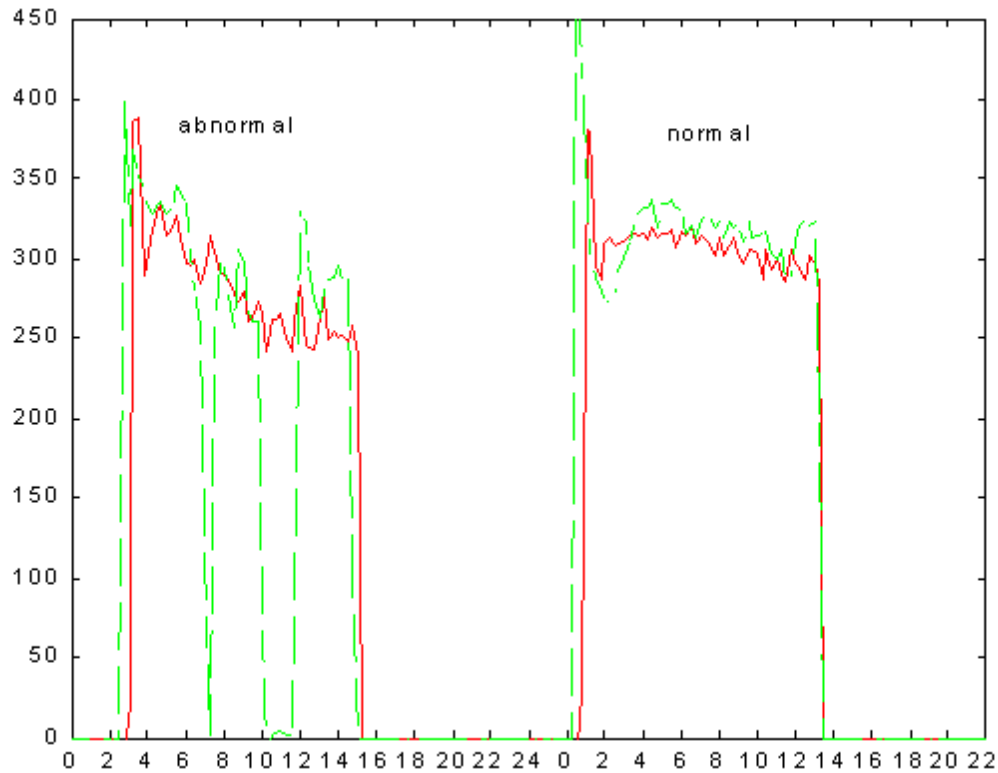

Figure 8: Heating coil subsystem abnormality.

Figure 9 shows a comparison between the mixing-box in the simulation and system during a day when large discrepancies existed. This type of difference was typical throughout the majority of the data used in the evaluation. The figure shows significantly more heat-transfer to the outside air from the return stream in the system than in the simulation. The most obvious reason for this is that the return air dampers in the mixing-box were leaking. Some leakage through air dampers is common in practice, but the actual extent of leakage was quite significant in the monitored system. For the one-year of data used in the evaluation, an average of 35% too much heat was transferred to the supply air.

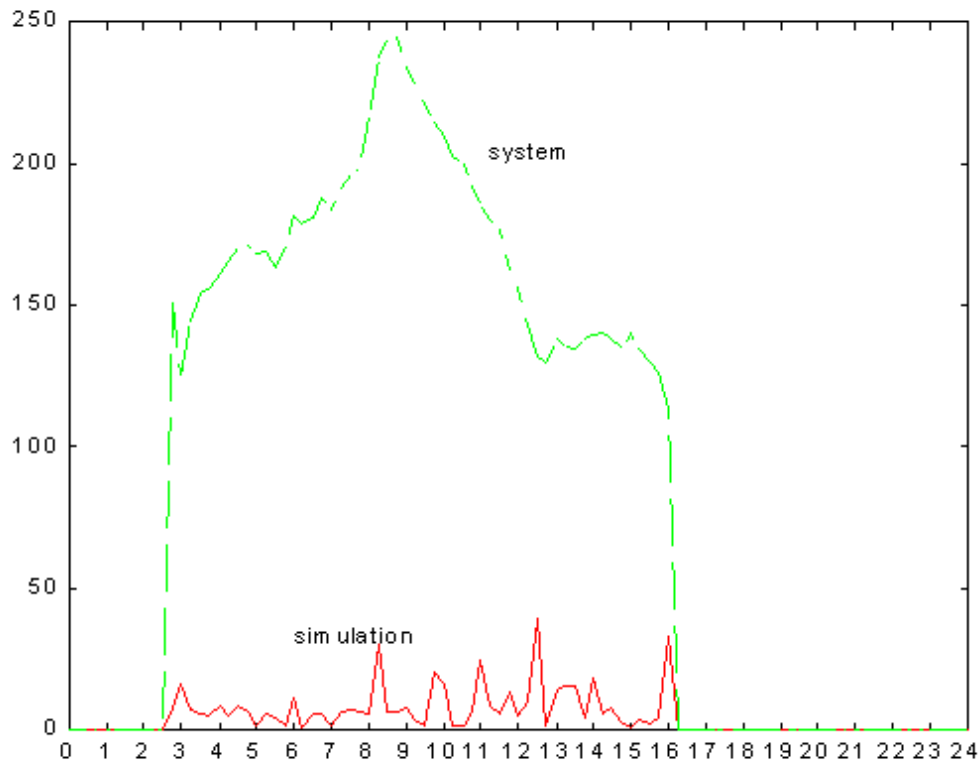

Figure 9: Mixing-box abnormality.

Figure 10 shows the performance of the cooling coil subsystem over a period of two days. The first day shows a reasonably good match between the simulation and system, although, as in Figure 5, there was a delay in the activation of the cooling coil. By contrast, there are significant discrepancies on the second day between the system and the simulation. It appears that the cooling coil is operating below its ideal capacity except for a short period in the middle of the day. There are a number of possible reasons for this, such as a chiller or pump failure, inadvertent change in setpoint, manual override, etc. It was not possible to confirm the exact reason for the behavior, but it is clear that some problem existed in the system.

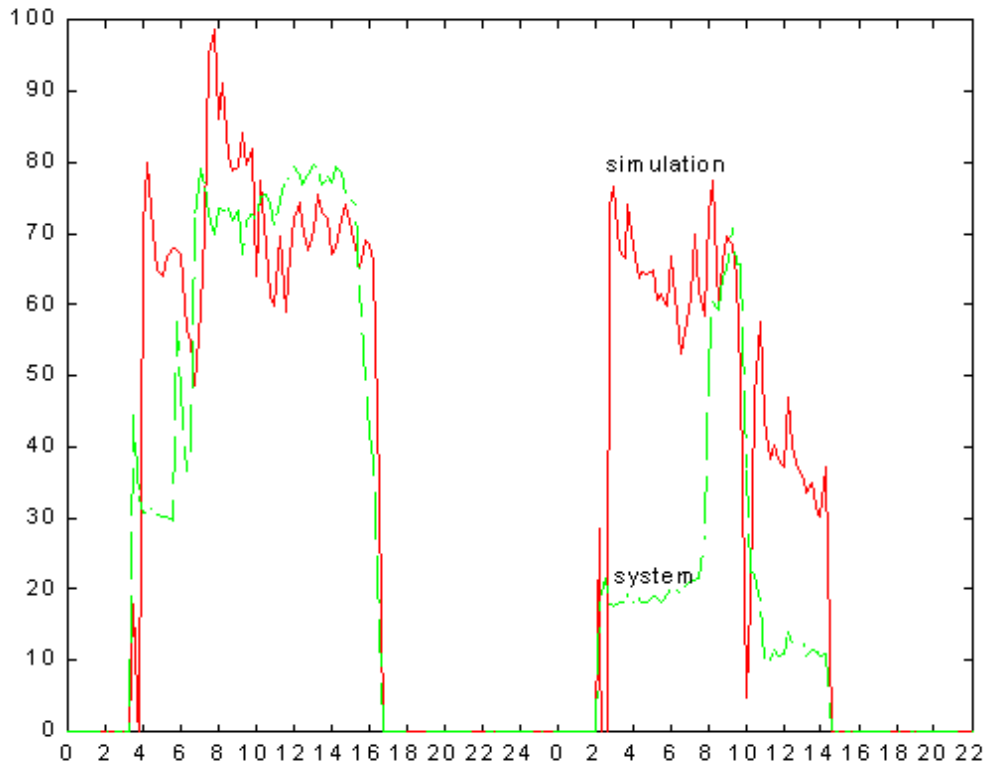

Figure 10: Cooling coil abnormality.

5.4 Energy Analysis

In addition to facilitating daily performance tracking, it is possible to use the simulation to evaluate longer-term energy use in the monitored system. This section compares the energy use of the system and the simulation over a one-year period.

Figure 11 shows the energy use breakdown for the three subsystems in the air-handling unit. The figure shows that all subsystems have higher heat-transfer rates in the real system than in the simulation. The most noticeable difference is the amount of energy transferred to the supply air by the mixing-box, with significantly more energy transferred in the real system than in the simulation. As explained previously, this was most likely due to leakage through the return air damper. Table 1 lists the potential savings in the real system, based on the assumption that the simulation represented an optimum level of performance.

Table 1: Annual energy use in system and simulation.

Subsystem	Annual Energy Use (MWh)		Potential Savings By Optimizing Each Subsystem	
	Simulation	System	(MWh)	(%)
Cooling Coil	128	146	18	12
Heating Coil	571	679	108	16
Mixing-box	24	201	177	88

Note that cost benefits are more directly attributable to the heating and cooling savings, whereas any changes in the mixing-box energy do not affect cost directly but affect the loads of the heating and cooling coils. Since the simulation was operated using sensors that isolated each of the three subsystems, the real mixed air conditions were used as inputs to the heating and cooling coil subsystems in the simulation. This meant that the leaking mixing-box also influenced the energy use predicted in the simulation for the heating and cooling coils.

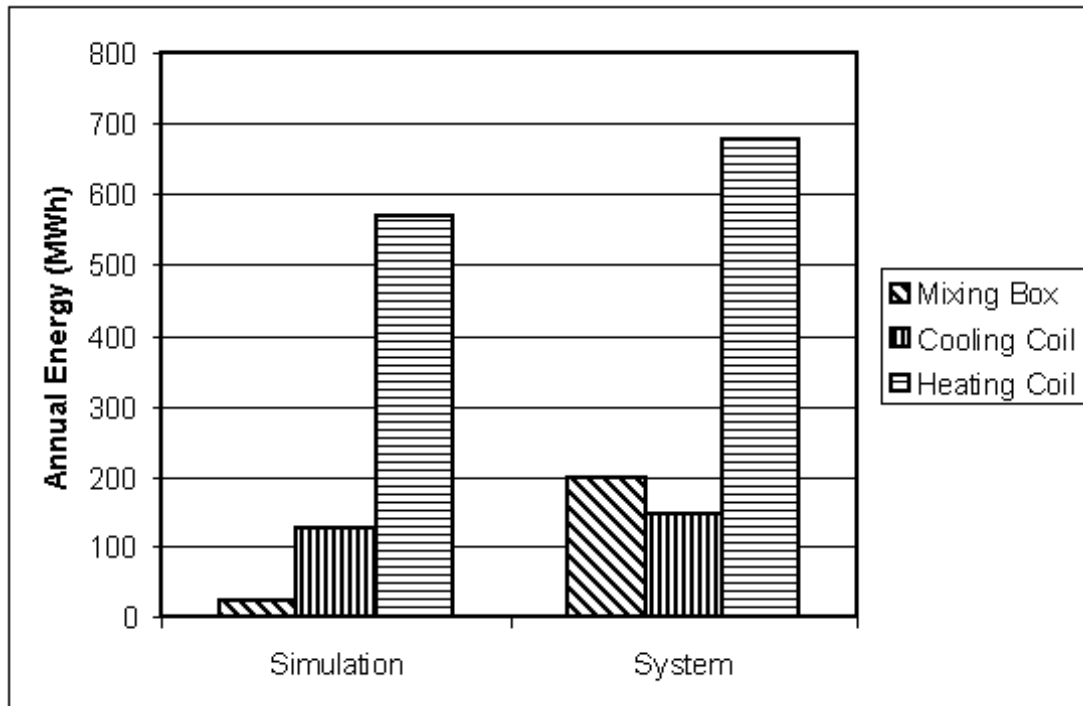

Figure 11: Annual energy comparisons in simulation and system subsystems.

In order to establish the effect of the leakage in the mixing-box on the heating and cooling energy, the simulation was re-configured to use the simulated mixed air conditions as inputs to the coils. Table 2 lists the results from re-running the simulation in this way. These results show that the leaking mixing-box reduced the load on the heating coil, but increased the load on the cooling coil. Hence, although a reduction of 16% in the energy use of the heating coil subsystem was possible by improving its control and operation, these savings reduce to 6% by eliminating the leakage in the

mixing-box. Conversely, energy savings from improving the cooling coil subsystem increase from 12% to 46% by fixing the mixing-box. Since cooling energy is more expensive than heating energy, these potential savings are economically significant.

Table 2: Results of running simulation with predicted mixed air conditions

Subsystem	Annual Energy Use (MWh)		Potential Savings By Optimizing All Subsystems	
	Simulation	System	(MWh)	(%)
Cooling Coil	80	146	66	46
Heating Coil	640	679	39	6

6 Conclusions

This paper has described an approach to performance validation based on simulation developed using simplified models. Using simplified models reduced the number of configuration parameters in the simulation. The objective was to use models configurable from data made available in the building life-cycle processes preceding operation. The simulation models were developed in-line with object and data specifications currently under development in the IAI.

Operating data collected from a large dual-duct air-handling unit installed in a large office building in San Francisco was used to demonstrate the performance validation potential of the techniques. It was shown how daily trend-plots comparing heat-transfer performance of the simulation and real system could reveal anomalies in system operation. Although there were only a small number of sensors installed in the real system, there was sufficient information to isolate the performance of three subsystems in the air-handling unit: heating coil, cooling coil, and mixing-box. Periodic disruptions were evident in the operation of the coils as well as control problems (manual and automatic). The simulation also allowed detection of leakage through the return dampers in the mixing-box.

The paper showed how simulation could be used to assess performance over an annual period. By assuming the simulation represented the optimum level of performance, it was possible to calculate statistics to predict the potential improvement possible for each air-handling unit subsystem. In this exercise, it was shown that 88% too much heat was being transferred in the mixing-box because of the leaking return-air damper. In the heating coil 16% too much heat was estimated as being transferred in the real system, while the cooling coil was estimated as 12% in excess. The effect of the mixing-box leakage on the heating and cooling energy was investigated by running the simulation using predicted, rather than measured mixed air conditions. Results showed that the mixing-box leakage reduced heating load and increased cooling load. Total potential savings in cooling energy were approximately 46%, while total heating savings were relatively small at 6%.

In order for simulation-based validation techniques to be viable, the configuration process has to be both accurate and not too labor-intensive. Data interoperability is an enabling

technology in this respect, which allows system information to pass from one life-cycle process to another, thereby simplifying the accumulation of simulation information at the operations phase. There is a need for further work in this area, and new applications, such as performance validation, have the potential to increase momentum by fostering applications-driven incentives. Further work is also required to develop ways of characterizing and visualizing HVAC system performance. The paper described how to use the simulation as a performance validation tool, but did not develop ways in which to perform the validation in detail, an area still needing significant work.

7 Acknowledgements

This work was supported by the Assistant Secretary for Energy Efficiency and Renewable Energy, Office of Building Technology and Community Systems, and the Federal Energy Management Program, of the US Department of Energy under Contract No. DE-AC03-76SF00098.

8 References

ASHRAE. 1995. "Standard 135-1995 - BACnet - A Data Communication Protocol for Building Automation and Control Networks". Published by ASHRAE.

Austin, S.B. 1997. "HVAC System Trend Analysis". ASHRAE Journal. February 1997. Volume 39. Number 2. Page 44.

Buswell, R., P. Haves, T. I. Salsbury. 1997. "A Model-Based Approach to the commissioning of HVAC Systems". *Proceedings of the CLIMA 2000 conference*. Brussels.

Clark, R. C. 1985. "HVACSIM+ Building Systems and Equipment Simulation Program Reference Manual". Published by the U.S. Department of Commerce, National Bureau of Standards, National Engineering Laboratory, Center for Building Technology, Building Equipment Division, Gaithersburg, MD 20899.

Clark, D. R., C. W. Hurley, C. R. Hill. 1985. "Dynamic models for HVAC system components". ASHRAE Transactions. Volume 91. Part 1B. Page 737.

Claridge, D., J. Haberl, M. Liu, J. Houcek, A. Athar. 1994. "Can You Achieve 150% Predicted Retrofit Savings? Is it Time for Re-Commissioning". Proceedings of the ACEEE 1994 Summer Study on Energy Efficiency in Buildings. Volume 5. American Council for and Energy Efficient Economy.

Dexter, A. L., M. Benouarets. 1995. "Generic Modelling of HVAC Plant for Fault Diagnosis". Proceedings of IBPSA Conference, Madison, Wisconsin, USA.

Dexter, A. L., M. Benouarets. 1996. "A Generic Approach to Identifying Faults in HVAC Plants". ASHRAE Transactions. Volume 102. Part 1. Page 550.

Diamond, R., T. I. Salsbury, G. Bell, J. Huang, O. Sezgen. 1998. "Phillip Burton Federal Building EMCS Retrofit Analysis. Final Report." LBNL Report.

- Ding, X., J. P. Eppe, J. Lebrun, M. Wasacz. 1990. "Cooling Coil Models to be used in Transient and/or Wet Regimes. Theoretical Analysis and Experimental Evaluation". Proceedings of the third international conference on System Simulation in Buildings, Liege.
- Fiscal, A., J. Thornton, S. A. Klein, W. A. Beckman. 1995. "Developments to the TRNSYS Simulation Program." Journal of Solar Energy Engineering. 123: 5.
- Haves, P., D. R. Jörgensen, T. I. Salisbury, A. L. Dexter. 1996a. "Development and Testing of a Prototype Tool for HVAC Control System Commissioning". ASHRAE Transactions. Volume 102. Part 1.
- Haves, P., T. I. Salisbury, J. A. Wright. 1996b. "Condition Monitoring in HVAC Subsystems using First Principles Models". ASHRAE Transactions. Volume 102. Part 1. Page 519.
- Herzog, P., L. LaVine. 1992. "Identification and Quantification of the Impact of Improper Operation of Midsize Minnesota Office Buildings on Energy Use: A Seven Building Case Study". Proceedings of the ACEEE 1992 Summer Study on Energy Efficiency in Buildings. Volume 3. American Council for and Energy Efficient Economy.
- Holmes, M. J. 1982. "The Simulation of Heating and Cooling Coils for Performance Analysis". Proceedings of the first international conference on System Simulation in Buildings, Liege. Page 245.
- Hyvärinen, J., S. Kärki. "Building Optimization and Fault Diagnosis Source Book". August 1996. ISBN 952-5004-10-4.
- Incropera, F., D. P. De Witt. 1990. "Introduction to Heat-transfer". Published by John Wiley and Sons, Inc.
- ISO 10303 - International Standards Organization. 1994. "Industrial automation systems and integration - Product data representation and exchange - Part 1: Overview and fundamental principles". ISO 10303-1:1994. ICS: 25.040.40.
- Kao, J. Y., E. T. Pierce. 1983. "Sensor errors and their effect on building energy consumption". ASHRAE Journal. Volume 25. Page 42.
- Lee, W. Y., J. M. House, C. Park. 1996. "Fault Diagnosis of an Air-Handling Unit using Artificial Neural Networks" ASHRAE Transactions. Volume 102. Part 1. Page 540.
- Ljungkrona, I., E. Abel, E. Isfalt. 1992. "Analysis of the Dynamic Energy Performance of an HVAC System by Combining Simulations and Measurements". ASHRAE Transactions. Volume 98. Part 2. Page 363.
- Park, C., S. T. Bushby. 1989. "Simulation of a Large Office Building System using the HVACSIM+ Program". ASHRAE Transactions. Volume 95. Part 1. Page 642.
- Rossi, T., J. Braun. 1993. "Classification of Fault Detection and Diagnostic Methods". Chapter 2 in "Building Optimization and Fault Diagnosis System Concept". Published by Technical Research Center of Finland.

Stephan, W., Gruschka. 1994. "Comparison of Different Models for Cooling Coils under Wet Conditions". Proceedings of the fourth international conference on System Simulation in Buildings, Liege. Page 291.

Trapp, G. 1993. "The Emerging STEP Standard for Product-Model Data Exchange". Computer. February, 1993. Volume 26. Number 2. Page 85.