

#5746

**CMHC Research Project
Testing of Air Barriers
Construction Details**

AUSSI DISPONIBLE EN FRANCAIS SOUS LE TITRE:

Projet de recherche de la SCHL Évaluation d'éléments
de construction assurant l'étanchéité à l'air

REPORT

**CMHC Research Project
Testing of Air Barriers
Construction Details**

Presented to:

Mr. Jacques Rousseau

CMHC
Project Manager

Canada Mortgage and Housing Corporation

Project Implementation Division
682 Montreal Road
Ottawa, Ontario
K1A 0P7

Report No. 30132.OR/2

August 26, 1991

Canada Mortgage and Housing Corporation, the Federal Government's housing agency is responsible for administering the National Housing Act.

This legislation is designed to aid in the improvement of housing and living in Canada. As a result, the Corporation has interests in all aspects of housing and urban growth and development.

Under Part IX of this Act, the Government of Canada provides funds to CMHC to conduct research into the social, economic and technical aspects of housing and related fields, and to undertake the publishing and distribution of the results of this research. CMHC therefore has a statutory responsibility to make widely available, information which may be useful in the improvement of housing and living conditions.

This publication is one of the many items of information published by CMHC with the assistance of federal funds.

DISCLAIMER

This study was conducted by the Morrison Hershfield Limited for Canada Mortgage and Housing Corporation under Part IX of the National Housing Act. The analysis, interpretations and recommendations are those of the consultant and do not necessarily reflect the views of Canada Mortgage and Housing Corporation or those divisions of the Corporation that assisted in the study and its publication.

EXECUTIVE SUMMARY

The airtightness of building envelopes has received increased attention in recent years. Leakage generally occurs through construction details, where there are joints or connections between materials, or where there are penetrations for services or other components rather than through the materials intended to provide the primary resistance to air leakage.

CMHC commissioned this project to quantify the air leakage characteristics of three such details in wood-frame walls: the header joist, the electric outlets, and the window opening detail. Three construction methods currently employed to achieve airtightness were evaluated:

1. The sealed internal membrane approach, where polyethylene sheet and sealant provide the air barrier (referred to herein as the POLY approach).
2. The external air barrier approach, which uses a continuous vapour permeable membrane (spun-bonded olefin film), sandwiched between two layers of external wall sheathing (referred to herein as the EASE approach).
3. The airtight dry wall approach, where the interior gypsum board finish, together with framing materials and gaskets, are used as the air barrier (referred to herein as the ADA approach).

In addition, to provide a reference for comparison, the traditional approach to wood-frame wall construction, where no special attention is given to achieving a continuous air barrier, was evaluated.

Twelve, 1.22 m x 2.44 m, test panels incorporating each of the three details were assembled using each of the four construction methods. The panels were sealed to the open face of an air leakage test chamber in which the air pressure could be increased or decreased with respect to the pressure in the laboratory to induce infiltration or exfiltration through the panel, and to subject the panel to uniform loads simulating those due to wind action. The panels were subjected to a sequence of pressure differences, from 50 Pa to 1000 Pa. Measurements of air flow were made at each pressure difference and any evidence of a

failure of the air barrier due to pressure loading was noted. The measurements were made at two or more stages in the assembly of each panel, in order to determine the effect of different components on the air leakage of the assembly and the effect of the simulated wind loads had on the integrity of the air barrier components at different stages of construction.

All test panels were constructed of 38 mm x 89 mm (2" x 4") wood framing with an indoor sheathing of 12 mm gypsum board. Exterior sheathing was 50 mm semi-rigid fibreboard for the POLY and ADA approaches, 12 mm chipboard for the conventional approach, and a layer of spun bonded olefin film (Tyvek) sandwiched between two sheets of 12 mm fibreboard for the EASE approach.

For the header joist detail, the POLY test panel had a layer of olefin film wrapped around the exterior face of the header which was sealed to the continuous polyethylene air/vapour barrier on the inside with acoustic sealant. The EASE test panel required no special treatment, as the sheathing sandwich was continuous over the header joist. The ADA panel used ethafoam gaskets between all joints in a vertical plane, from the edges of the gypsum board to the foundation sill plate. In the traditional test panel, the polyethylene vapour retarder was installed between the wall framing and the gypsum board, but no attempt was made to seal it at the edges, and the chipboard sheathing was continuous over the exterior surface of the header joist.

For the window detail of the POLY test panel, plywood strips were sealed to the outside surface of the window frame prior to installation in the rough frame opening, and the polyethylene air barrier sealed to the plywood with acoustic sealant. In the EASE test panel, the olefin membrane was wrapped around the rough frame of the window opening, and the shim space was filled with one-part urethane foam. In the ADA test panel, a strip of duct tape between the window frame and gypsum board was used to bridge the shim space. In the traditional test panel the polyethylene was cut out of the rough frame opening and the shim space stuffed with fiberglass insulation.

For the electrical outlet detail of the POLY test panel, pre-formed polyethylene pans were fitted through a plywood panel support let into the studs, and the flanged surfaces of the pans were sealed to the polyethylene air barrier with acoustic sealant; an electrical box was installed in each pan, nailed to the adjacent stud through the pan wall; the hole in the back of each pan, through which electric cable was carried, was sealed with acoustic sealant. The EASE panel required no special treatment, as the sheathing sandwich was not penetrated by the box detail. In the ADA panel, the gypsum board was simply cut around the box and a

closed cell face gasket was placed between the drywall and the electrical outlet cover plate. No measures were taken to seal the electrical box detail in the traditional panel.

Test results for the header detail indicated that leakage rates for the POLY, EASE, and ADA panels were about 24%, 18% and 10% respectively of that for the traditional panel at the standard reference pressure difference of 75 Pa. During the test series on the POLY panel, prior to installation of the interior wall board, an acoustic sealant joint, between polyethylene and olefin membranes, failed at 50 Pa in the infiltration mode. Most of the air flow resistance of the traditional panel was provided by the chipboard sheathing.

For the electrical outlet detail, the leakage rates for the POLY and EASE panels were about 24% and 36% of that for the traditional panel at 75 Pa pressure difference. The ADA panel had a higher leakage rate than the traditional panel, associated with the gap in the air barrier system around the electrical boxes.

For the window detail, leakage rates were lowest for the ADA panel and similar for the POLY and EASE panels; all were less than 15% of that for the traditional panel.

In the test series prior to installation of the interior wall board, the POLY panel again exhibited failure of the air barrier system at the juncture of the polyethylene and plywood around the window frame; this occurred in the infiltration mode at a pressure difference of 100 Pa.

Overall, all but the traditional panels and the ADA electrical outlet panel exceeded the current tightness standards for glass and aluminum curtain walls, but only the ADA window panel met a suggested goal proposed by NRC researchers. All three could be used to construct walls of houses intended to meet airtightness standards of the R-2000 program of those tested. The window detail appears to offer the greatest potential for increasing overall house airtightness.

Some of the techniques for achieving an effective air seal at construction details can be applied to more than one air sealing system.

There remains some uncertainty about the possibility of permanent damage to acoustic sealant joints in the POLY approach when subjected to moderate-to-high wind speeds during construction, prior to installation of the interior wall board.

TABLE OF CONTENTS

	Page
1. INTRODUCTION	1
2. OBJECTIVES AND SCOPE	3
2.1 Objectives	3
2.2 Scope	3
3. LOW LEAKAGE CONSTRUCTION METHODS	5
3.1 POLY Approach (Polyethylene Membrane and Acoustical Sealant)	5
3.2 EASE Approach (Exterior Air System Element)	6
3.3 ADA Approach (Airtight Drywall Assembly)	6
4. METHODOLOGY	8
4.1 Apparatus	8
4.2 Equipment and Instrumentation	10
4.3 Test Procedure	11
5. DESCRIPTION OF TEST PANELS	13
5.1 Header Joist Detail	13
5.1.1 Panel No. 1 - Poly Approach	13
5.1.2 Panel No. 2 - Ease Approach	15
5.1.3 Panel No. 3 - ADA Approach	15
5.1.4 Panel No. 4, Traditional Approach	16
5.2 Electrical Outlets	16
5.2.1 Panel 5 - Poly Approach	16
5.2.2 Panel 6 - Ease Approach	18
5.2.3 Panel 7 - ADA Approach	18
5.2.4 Panel No. 8 - Traditional Approach	18
5.3 Window Detail	18
5.3.1 Panel 9 - Poly Approach	20
5.3.2 Panel 10 - EASE Approach	20
5.3.3 Panel 11 - ADA Approach	20
5.3.4 Panel 12 - Traditional Approach	21

TABLE OF CONTENTS (CONTD.)

	Page
6. RESULTS AND COMMENTARY	22
6.1 Header Joist Detail	22
6.2 Electrical Outlets	27
6.3 Window Detail	30
7. DISCUSSION	35
7.1 Overall Air Leakage	35
7.2 Air Leakage at Details	38
7.3 Structural Performance	40
7.4 Issues for Further Study	41
8. CONCLUSION	43

APPENDIX A: Description Level of Construction For Each Test Sequence

APPENDIX B: Graphic Test Results

1. INTRODUCTION

Over the last fifteen years there has been growing awareness throughout the building industry of the problems associated with air leakage through building envelopes. One of the main concerns is deterioration of construction materials, if airborne moisture is allowed to deposit and collect within the wall system. This has led to a recognition of the benefits of providing more airtightness in building envelopes to the point that the National Building Code now incorporates air barrier requirements. Part 5 of the National Building Code calls for the building assembly to provide an effective barrier against air infiltration and exfiltration through materials, joints and junctions in the assembly. In the 1990 edition, Part 9 calls for a continuous barrier to the leakage of air from the interior into wall, floor and attic or roof spaces. There is a clause on air barrier materials and several clauses on the installation of air barrier systems.

CMHC has undertaken several studies to quantify the air permeability of specific materials and assemblage of materials commonly used in residential construction. However, it has been observed throughout the housing industry that it is not sufficient that the materials and components of the air barrier have sufficient resistance to air flow. Air leakage at the connections between components providing the air barrier and at penetrations through it by structural components and services usually determine the overall effectiveness of the air barrier system. There are numerous details of this nature, used for residential wall construction, that require specific attention in the design of air barrier systems, such as: the connection between interior partitions and exterior walls; the foundation wall to sill plate joint; windows (to rough stud opening); the header joist detail; and the electrical outlet detail.

CMHC commissioned this project to quantify the air leakage characteristics of some of these details. Three were chosen for testing: the header joist, the electrical outlet and the window detail. Test specimens incorporating these construction details were fabricated and air leakage through them was measured over a range of pressure differences, including the highest pressures that could be expected from peak wind loads. The air leakage tests were carried out at successive stages in the construction of each specimen in order to determine the effect on airtightness of different components.

When evaluating the performance of any air barrier system one must keep in mind that the wall system can remain for some time in an unfinished state. During this period, some elements of the wall may be unprotected from high wind loads and be vulnerable to damage that may never be repaired. This can cause localized leakage paths with the possibility of high rates of air exfiltration at these locations. This in turn can be very detrimental to the performance of the envelope as it can lead to high rates of water vapour condensation, and resulting water damage at these locations.

The building industry has developed a number of methods of construction to resist air leakage. This study addressed three:

1. the sealed internal membrane approach, where polyethylene sheet and sealant provide the air barrier (we will refer to this method as the POLY approach);
2. the airtight drywall approach where the interior gypsum finish is used as the air barrier (we will refer to this method as the ADA approach); and
3. the external air barrier approach which uses a continuous vapour-permeable membrane sandwiched between two layers of exterior wall sheathing (we will refer to this method as the EASE approach).

To provide a reference for comparison we also tested wall specimens using:

4. a traditional approach to house construction, where no special attention is given to sealing the building against air leakage (we will refer to this method as the Traditional approach).

2. OBJECTIVES AND SCOPE

2.1 Objectives

The objectives of the test program were to evaluate and compare the ability of the four previously described construction approaches to provide air barrier systems for walls which resist air leakage and wind structural loads. Performance was evaluated in both a finished condition and in unfinished conditions, recognizing that damage caused by wind forces during the construction process may not be repaired.

2.2 Scope

Testing was carried out on twelve test specimens incorporating three common construction details and using the four air barrier approaches. These were tested at various stages of completion to determine their air leakage rates and the ability of the air barrier to resist damage from wind loads (structural performance). The construction details were:

1. the header joist detail;
2. the electrical outlet detail in an exterior wall; and
3. the window shim space detail.

Each detail was incorporated into four test panels, each using one of the four air barrier approaches. While these details represent only a limited sample of the total number of details in a building, they were deemed to be among the most significant.

The test pressure differences at which air leakage was measured ranged from 50 Pa to a maximum of 1000 Pa (or the pressure difference at which the air flow through the test section was limited by the capacity of the air moving system - about 25 L/S). The 1000 Pa limit was selected as an appropriate limit for validating structural performance against wind loads in low rise, wood framed buildings. It is significantly higher than the hourly wind pressure figures published in the National Building Code but one can expect that, in some areas, gust pressures could reach this level.

While the 1990 building code requires that all buildings be provided with a continuous air barrier, no air leakage performance criteria are given to use as an accepted standard. However, Building Science insight 86, "An Air Barrier for the Building Envelope" recommended that air leakage should not exceed 0.1 l/s/m^2 at a pressure difference of 75 Pa. We have used results of this test pressure as the basis for comparing and rating the various details and construction types.

3. LOW LEAKAGE CONSTRUCTION METHODS

This study used test sections which incorporated problematic details (header joists, electrical outlets, and windows) constructed using three different construction approaches that have been used to build tighter houses. Until the 1980's, little attention was given to achieving airtightness in low rise construction. Traditionally the airtightness of houses was achieved through the inherent resistance to air flow of sheathing materials and vapour barrier membranes, the tightness in fit between components, the airtightness of material used to fill the space between the rough openings and frames of windows and doors, and the effect of exterior caulking used to provide weather tightness.

With the more general recognition of the importance of controlling air leakage through the building envelope, three basic construction approaches to achieving airtightness have evolved. Two are based on using a sealed, flexible membrane and the third uses the rigid interior cladding materials and framing components as the plane of airtightness.

3.1 POLY Approach (Polyethylene Membrane and Acoustical Sealant)

The POLY Approach uses the polyethylene vapour retarder and acoustical sealant to form the airtightness plane. Polyethylene, as a material, is essentially airtight and has a low water vapour permeability. It is, however, susceptible to deterioration when exposed to ultra violet radiation, it requires structural support to resist high wind loads, and it requires overlapping joints with mechanical clamping between rigid members for durable sealing. These limitations can be overcome by proper design and construction of envelope assemblies but it is obvious that polyethylene should not remain exposed to the elements for long periods. Prolonged exposure to sunlight does not usually occur during construction (walls are typically sheathed from the outside in), but there are periods during construction when the air barrier is susceptible to damage if exposed to high wind pressures without the support of interior drywall. Any damage may not be noticed prior to installing the gypsum board finish and may therefore never be repaired.

There has also been some concern expressed that movement of the membrane under wind loads can cause tearing at staples and displacement of non-rigid insulation.

3.2 EASE Approach (Exterior Air System Element)

The more recently developed EASE approach also uses a membrane to provide the airtightness plane but it is located on the cold side of the insulation. In this location in the building envelope the membrane must be relatively permeable to water vapour in order to facilitate the escape of any accumulated moisture, so a spun bonded olefin membrane is used. Structural support is provided by sandwiching the membrane between two layers of fibreboard (or other rigid sheathing material). Vapour diffusion control on the warm side of the insulation is provided by an adequate vapour retarder which need not be air sealed.

While this method of construction is not as common as the POLY approach, advocates point out that the air barrier is the first element of the wall to be erected. This provides some protection to the other elements of the wall and reduces the risk of damaging the air seal since it is always supported by rigid materials that are intended for use in exposed conditions.

The EASE approach eliminates many of the problems associated with penetrations through the interior gypsum board such as framing, electrical outlets, and light switches. However, from a building science perspective, placing the air barrier on the exterior or cold face of the building can allow the interchange of air between indoors and insulated wall spaces due to convective forces, if leakage openings through the interior cladding occur at two or more levels. The amount of this air interchange depends on the effective size of the openings and the difference in their elevations. While these convective forces are likely to be less than air pressure differences due to wind and house stack effects, the interior surface still needs to be reasonably well sealed in order to avoid excessive condensation. Because the EASE barrier is relatively permeable to water vapour, it does allow drying by diffusion to the outside.

3.3 ADA Approach (Airtight Drywall Assembly)

The ADA or "airtight drywall assembly" approach relies on rigid interior cladding materials, such as gypsum board, and gaskets to resist air flow. While not effective as a vapour retarder, gypsum board is highly resistant to the passage of air. Being a rigid material, it is also not likely to be damaged by high air pressure differentials. Also, great care is typically given to its installation as it is the finished surface.

Therefore any screw holes will be covered with dry-wall joint compound. The water vapour resistance required can be provided by using foil backed drywall, polyethylene or vapour resistant paints.

4. METHODOLOGY

The basic procedure established for this project used a series of air pressure tests on each of twelve test panels at various stages of their assembly. Taking measurements following each stage in the construction of the specimens made it possible to establish the contribution to airtightness of various components of the assembly. It also made it possible to identify the air pressure load being carried by the various components, such as the exterior sheathing, insulation, polyethylene and drywall (Appendix A and B). In order to isolate the air leakage through each test specimen, steps were taken to minimize the leakage around the perimeter of the test panel and to include it with the chamber leakage, to establish the total extraneous leakage. In order to aid in minimizing the perimeter leakage, where possible, the panels were placed in the chamber with the air barrier material sandwiched against the perimeter seal.

4.1 Apparatus

To facilitate the test sequencing, a chamber was designed to allow easy removal and installation of the twelve wall panels described in detail in Section 5. The chamber consisted of an exterior perimeter frame of 38 mm x 286 mm (2" x 12") wood members, and an interior perimeter frame (screwed to the exterior frame) of 38 mm x 190 mm (2" x 8") wood members. Three, uniformly spaced, horizontal members were fixed to the vertical members of the interior perimeter frame to provide additional structural support for the 1200 mm x 2400 mm x 20 mm plywood sheet covering one face of the frame to form a box. Closed cell foam gaskets were used as a seal between the chamber framing and the plywood sheet and each joint and screw hole was sealed with acoustic or silicon sealant.

The resulting chamber was essentially a back-up wall for the test panels. Figure 4.1 is a schematic representation of the test apparatus.

As seen in Figure 4.1, the test panels were placed against a closed cell gasket located along the edge of the 38 mm x 190 mm chamber framing, with the "outdoor" surface of the panels facing the inside of the chamber, and the "indoor" surface of the panels exposed to the laboratory environment.

Schematic Drawing

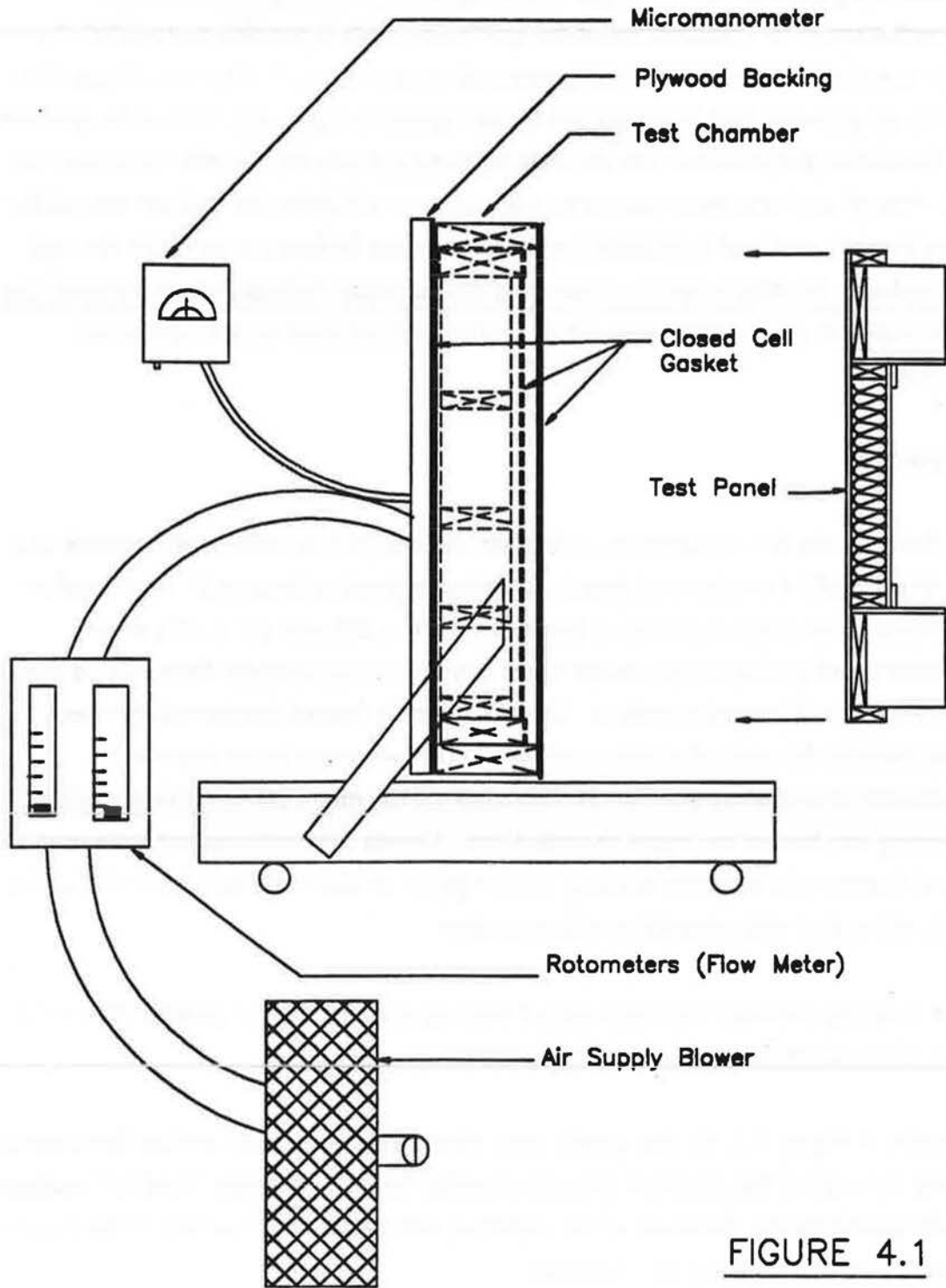

FIGURE 4.1

The test panel was held in place and compressed against the perimeter seal of the chamber opening with five "C" clamps, two on each vertical edge of the panel and one at the midpoint of the upper horizontal edge; and by a series of wedges at the bottom of the panel.

4.2 Equipment and Instrumentation

Pressure differentials were created with a 12 amp vacuum cleaner blower. Reinforced corrugated vinyl hoses were used to connect the chamber, flow meters and the air blower. The hoses connected to the suction and discharge openings of the blower were both fitted with valves that controlled the air flow rates. The hose from either the discharge or suction side of the blower could be clamped to a pipe connection fitted to the plywood face of the chamber, to increase or decrease the pressure in the chamber relative to the laboratory, inducing either infiltration or exfiltration through the test panel.

The flow of air was measured with rotometer-type flow meters. The rotometers were arranged in sets containing one high and one low flow rate meter. The rotometers used at the beginning of the study formed part of a Schlegal window test unit. The range of the high flow rate meter for this set was 10 to 50 cfm. The range of the low flow meter was 1 to 12 cfm. In later tests the above rotometers were replaced with a more permanent test arrangement using "DWYER" rotometers. The high flow rate meter in this set had a range of 1 and 30 cfm while the low flow rate meter had a range of 1 to 10 cfm. In all cases the calibrations provided by the manufacturer of the flow meters were used to establish the flow rates.

A pressure tap was installed through the plywood backing of the test chamber, and pressure differentials were measured with a Air Instrument Resources Ltd. micromanometer used on the 0-1999 Pa range.

Air temperature and relative humidity levels were taken with a Solomat prior to each test. The air temperatures ranged from 21°C to 23°C and the RH fluctuated within 19% to 42% RH.

4.3 Test Procedure

A series of air flow measurements were made with each test panel at each stage of completion, first in the infiltration mode and then in the exfiltration mode. In each case the pressure difference across the panel was increased from 50 to 1000 Pa, with air flow measurements at pressure differences of 50 Pa, 75 Pa, 100 Pa, 150 Pa, 200 Pa, 300 Pa, 400 Pa, 500 Pa, 600 Pa, 800 Pa and 1000 Pa. The pressure difference was then decreased, with air flow measurements taken again at 600 Pa, 200 Pa and 75 Pa, to verify earlier readings and to find out if the air barrier had been damaged at higher pressures. The pressure difference was maintained at each setting until air flow readings had stabilized.

During testing, wall sections were observed for signs of failure. In particular, an unexpected drop in the pressure difference at a particular control valve setting, or a significantly higher flow rate at a particular pressure difference during the verification measurements, were noted as a possible indication of rupture of some component of the test panel. In general the following procedure was followed for each of the three construction details:

1. The test panel was constructed up to the first stage of completion.
2. The "outdoor" face of the test panel was covered with a sheet of polyethylene and it was then mounted in the test chamber opening and clamped in place. Air leakage rates at the test pressures were determined with this sealed wall and the results recorded as extraneous chamber leakage. The extraneous leakage value was subtracted from all following air flow test values to determine the air leakage through the test panel.
3. The test panel was detached from the chamber, the polyethylene sheet removed and the panel remounted. The air leakage test series was repeated and the results, less extraneous leakage, were recorded as leakage through the test panel at the first level of completion.
4. The test panel was then constructed up to the second level of completion, and the test series was repeated. The number of levels of completion, and test series per panel, varied between the different construction approaches and details. However, the minimum number of levels of completion tested was

two and the maximum number was four. A test series at a particular level of completion of a panel is referred to as a test sequence. The sequencing for each panel is summarized in appendix A.

5. After each test sequence, the wall materials were reviewed for signs of damage and any damaged was documented. The damaged area was then repaired prior to constructing up to the next level of completion.

5. DESCRIPTION OF TEST PANELS

The Canadian construction industry currently use two basic framing dimensions, 38 mm x 140 mm (2" x 6") wood studs at 600 mm (24") on center or, 38 mm x 89 mm (2" x 4") at 400 mm (16") on centers. For the purposes of this study we elected to standardize on the 38 x 89 mm framing system for ease of handling test sections. It seems probable that similar results would be obtained with 38 mm x 140 mm framing.

Each test panel was 1.21 m (4') high by 2.44 m (8') wide and was designed to incorporate a significant quantity of the detail being evaluated.

When insulating sheathing was used, a frame consisting of 38 mm x 89 mm (2" x 4") wood members was fitted around the perimeter of test panel to facilitate sealing and clamping. In the case of panel # 3, (the header joist detail, ADA Approach) the frame also allowed the panel to be loaded vertically to the approximate building dead load that would normally compress the sill gaskets.

Builders, using the basic construction approaches outlined in Section 3, have developed a variety of ways of addressing air leakage at each of the specific construction details we tested. We, selected on the basis of conversations with industry advisors.

5.1 Header Joist Detail

This detail incorporated the joints between the foundation sill plate, the header joist, the plywood flooring and the bottom plate of the wall framing above. In order to maximize the lineal feet of joint, the upper section of the panel was the mirror image of the lower section. The four test sections addressing this detail are shown in Figure 5.1.

5.1.1 Panel No. 1 - Poly Approach

This detail used a spun bonded olefin film sheet (Tyvek[®]) to wrap the exterior face of the header joist. This connected to the polyethylene air/vapour barrier on the inside. A bead of acoustic sealant was placed between the Tyvek sheet and the polyethylene at each of the bottom plate locations. 12 mm gypsum board was attached to the studs with standard

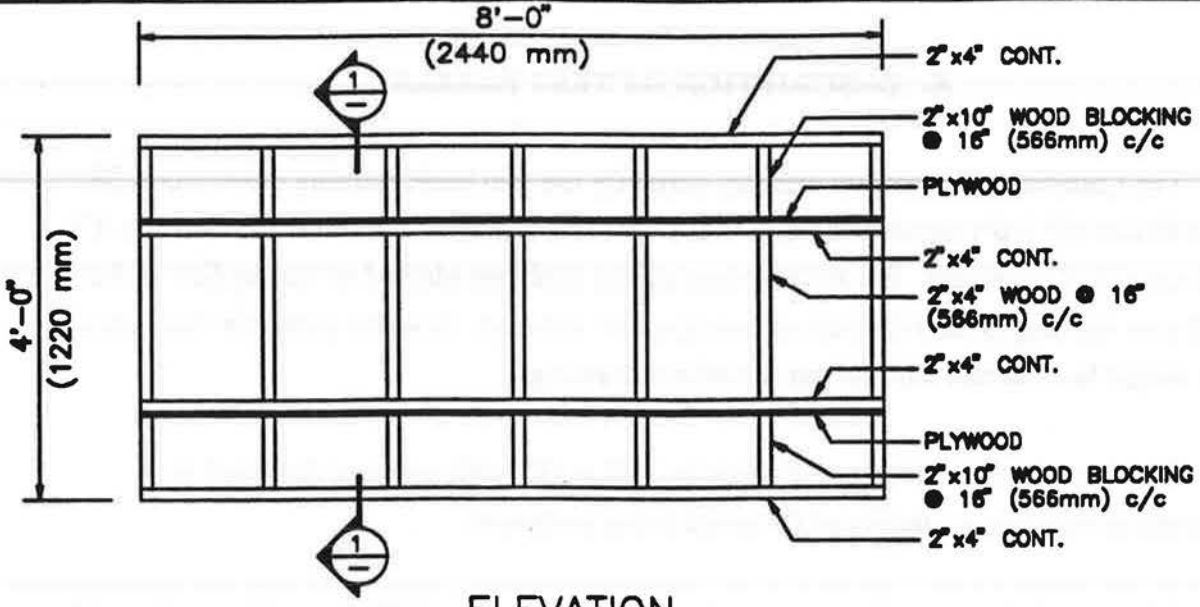

ELEVATION

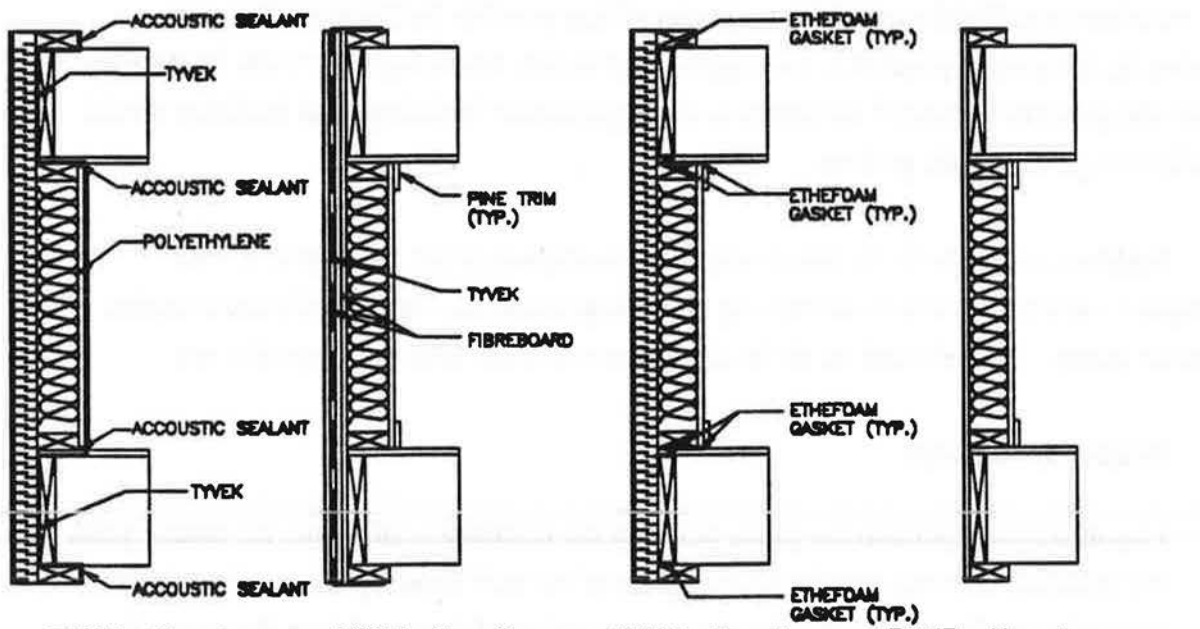

PANEL No. 1 POLY APPROACH PANEL No. 2 EASE APPROACH PANEL No. 3 ADA APPROACH PANEL No. 4 TRADITIONAL APPROACH

SECTION 1

	PANEL No. 1 POLY APPROACH	PANEL No. 2 EASE APPROACH	PANEL No. 3 ADA APPROACH	PANEL No. 4 TRAD. APPROACH
EXT. SHEATHING	GLASS CLAD	FIBREBOARD & TYVEK	GLASS CLAD	3/4" CHIP BOARD
NAIL SPACING	6" EXTERIOR/12" INT.	6" EXTERIOR/12" INT.	6" EXTERIOR/12" INT.	6" EXTERIOR/12" INT.
AIR BARRIER	8 MIL POLYETHYLENE	TYVEK	FOIL BACK GYPSUM BD.	N/A
VAPOUR BARRIER	8 MIL POLYETHYLENE	FOIL BACK GYPSUM BD.	FOIL BACK GYPSUM BD.	4 MIL POLYETHYLENE

HEADER JOIST DETAIL

FIGURE 5.1

Morrison Hershfield Limited
Consulting Engineers **MH**

drywall screws at every 300 mm around the perimeter of the drywall and one screw was placed at the mid-point of each stud. A 1" x 4" strip of pine trim was installed with 2 finishing nails at each stud. The exterior 50 mm thick, semi rigid fiberglass sheathing (GLASCLAD) was nailed to studs and plates and not through the header area where nails would have penetrated the header wrap membrane.

The spun bonded olefin sheet is used to control air leakage in this application because it allows drying by diffusion of excess moisture in the header. This could result from the winter-time condensing of water vapour on or in the header due to the relatively small thermal resistance provided by the insulation outside the header joist.

5.1.2 Panel No. 2 - Ease Approach

This panel used the same framing as panel no. 1. The exterior air barrier was made by first loosely attaching a layer of 12 mm fibreboard on the exterior surface of the studs and header using roofing nails. This surface was covered with TYVEK, stapled as required to hold it in place. A second sheet of fibreboard was then installed, nailing with longer roofing nails on 300 mm centers.

As seen in Figure 5.1 the exterior air barrier (sandwiched olefin membrane) extends past the header joist and under the foundation sill plate. It is therefore not interrupted by the header joist detail. In practice, it would be connected to the foundation wall below. In the test panel it was sealed to the bottom of the sill plate with tape.

The interior surface and vapour retarder were provided by 12 mm, foil backed gypsum board, attached with drywall screws on 300 mm centres. Screw heads were covered with a layer of drywall compound.

5.1.3 Panel No. 3 - ADA Approach

This panel used open cell, ethafoam gaskets 100 mm wide by 5 mm thick to seal framing joints. These were placed between the foundation sill plate and header joist; the header joist and plywood flooring; and the plywood flooring

and bottom wall plate. The interior air barrier and vapour retarder were provided by a sheet of 12 mm, foil backed gypsum board attached with drywall screws on 300 mm centers. All screw heads were covered with a layer of drywall compound. An ethafoam gasket was also placed between the wall framing and the perimeter of the gypsum board to prevent air leakage at the edges.

This panel used the same semi-rigid fibre glass exterior sheathing as Panel No. 1.

To simulate the field compressive load that would help seal gasket joints, 500 kg of weights were evenly applied to the top of the test panel before the drywall was installed and left there during testing.

5.1.4 Panel No. 4, Traditional Approach

In this case no special attention was given to airtightness of framing joints. A continuous 4 mil polyethylene vapour retarder was installed between the framing and 12 mm gypsum board interior sheathing but no attempts were made to seal it at the edges. 12 mm chipboard sheathing was used on the exterior. This was nailed in place with 2 1/2" nails spaced at 150 mm (6") centres over perimeter framing at 300 mm (12") centers over other studs.

5.2 Electrical Outlets

Figure 5.2 shows details of the four test panels that incorporated the electrical outlet detail. Six electrical boxes, one in each stud space, were installed in each panel. The exterior sheathing for each test panel was assembled in two 1.2 m x 1.2 m (4' x 4') sections. Joints between the air barrier of the wall system and the perimeter of the test panels were sealed.

5.2.1 Panel 5 - Poly Approach

This panel used a "Poly Pan" behind the electrical box to maintain the continuity of the air barrier. The "Poly Pan" consisted of a heavy gauge pre-formed polyethylene membrane that was fitted through a

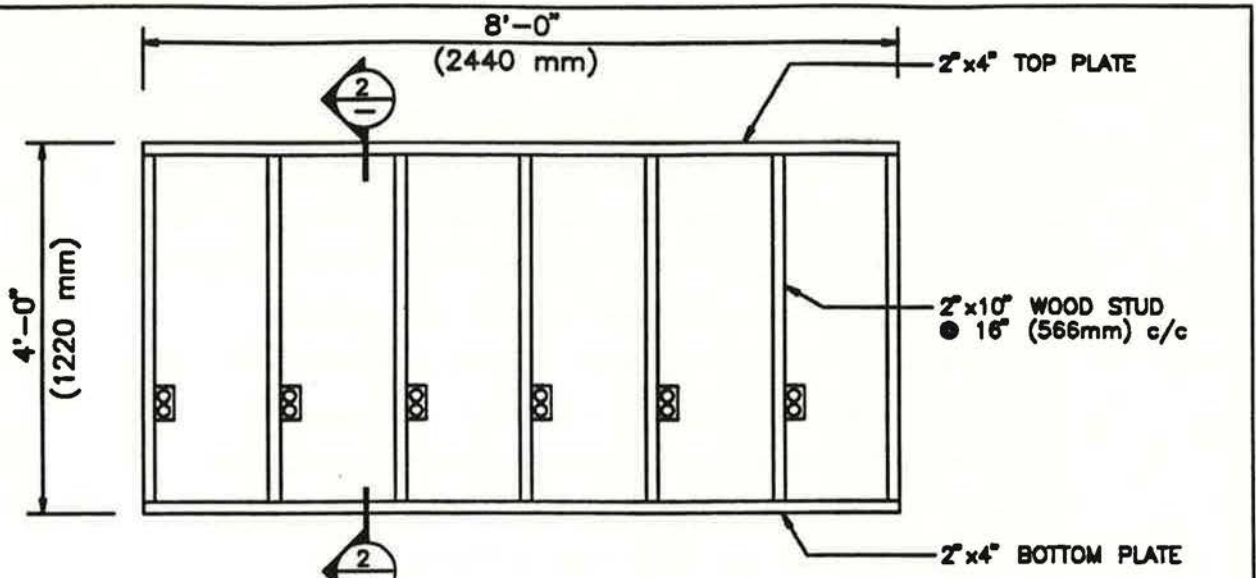

ELEVATION

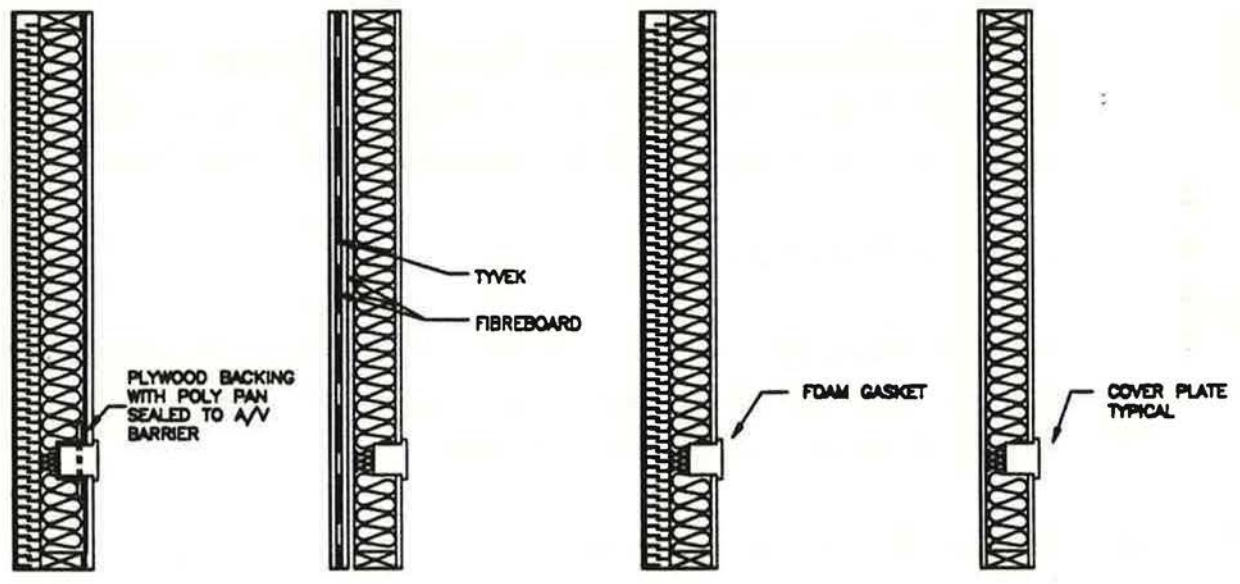

PANEL No. 5 POLY APPROACH PANEL No. 6 EASE APPROACH PANEL No. 7 ADA APPROACH PANEL No. 8 TRADITIONAL APPROACH

SECTION 2

	PANEL No. 5 POLY APPROACH	PANEL No. 6 EASE APPROACH	PANEL No. 7 ADA APPROACH	PANEL No. 8 TRAD. APPROACH
EXT. SHEATHING	GLASS CLAD	FIBREBOARD & TYVEK	GLASS CLAD	3/4" CHIP BOARD
NAIL SPACING	6" EXTERIOR/12" INT.	6" EXTERIOR/12" INT.	6" EXTERIOR/12" INT.	6" EXTERIOR/12" INT.
AIR BARRIER	6 MIL POLYETHYLENE	TYVEK	FOIL BACK GYPSUM BD.	N/A
VAPOUR BARRIER	6 MIL POLYETHYLENE	FOIL BACK GYPSUM BD.	FOIL BACK GYPSUM BD.	4 MIL POLYETHYLENE

ELECTRICAL OUTLET DETAIL

FIGURE 5.2

plywood backing support that was let into the stud framing (i.e., a notch was cut into the stud to allow for the plywood). It was penetrated by the nails used to fix the electrical box to the studs. The Poly Pan was then sealed to the Polyethylene air barrier with acoustic sealant; a minimal number of staples were used to support the polyethylene prior to sheathing the interior. Upon sheathing, drywall screws were driven through the drywall and plywood backer to clamp the joint between the poly pan and polyethylene air/vapour barrier. Wires were also installed through holes punctured in the poly pan. These were sealed with acoustic sealant.

5.2.2 Panel 6 - Ease Approach

The electrical boxes did not interrupt the exterior air barrier in this panel. A traditional electrical outlet detail was used. Electrical boxes were installed on the studs and matching holes cut in the gypsum board prior to installation.

5.2.3 Panel 7 - ADA Approach

A traditional electrical outlet box detail was used in this panel. To maintain the continuity of the air barrier, a closed cell face gasket was placed between the drywall and the electrical outlet cover plates .

5.2.4 Panel No. 8 - Traditional Approach

No measures were taken to seal the electrical boxes in this panel. The polyethylene vapour retarder used in the panel was cut out around the box and matching holes cut in the drywall sheathing prior to installation..

5.3 Window Detail

The four test panels that incorporated the window detail were fitted with two, 325 mm x 600 mm, fixed window units as illustrated in Figure 5.3. Again, the air barrier of the wall system was sealed at the perimeter of the test panel.

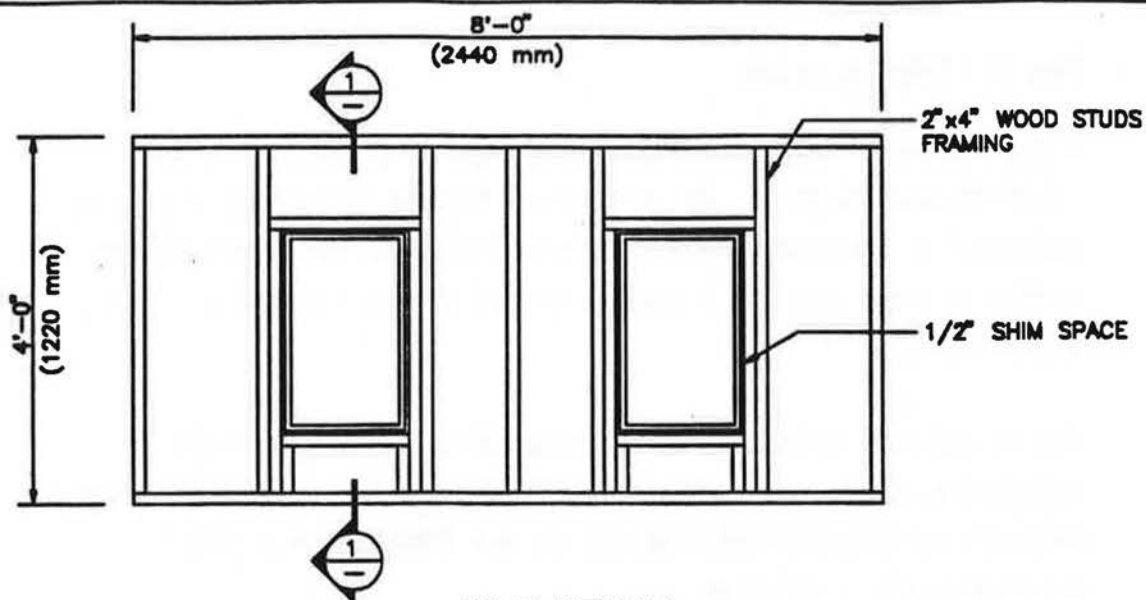

ELEVATION

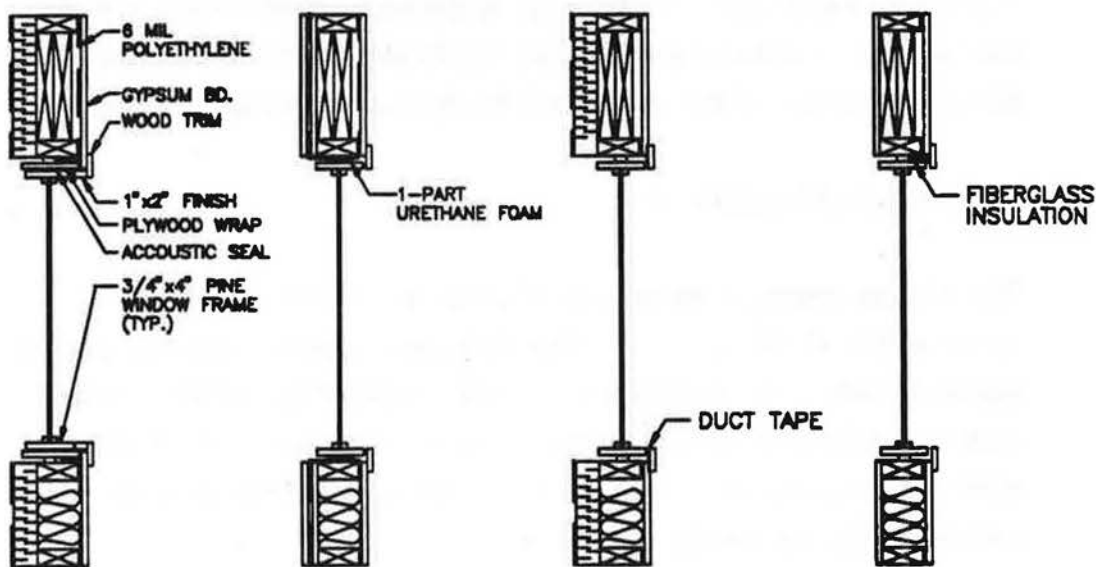

PANEL No. 1
POLY APPROACH

PANEL No. 2
EASE APPROACH

PANEL No. 3
ADA APPROACH

PANEL No. 4
TRADITIONAL APPROACH

SECTION 1

	PANEL No. 1 POLY APPROACH	PANEL No. 2 EASE APPROACH	PANEL No. 3 ADA APPROACH	PANEL No. 4 TRAD. APPROACH
EXT. SHEATHING	GLASS CLAD	FIBREBOARD & TYVEK	GLASS CLAD	3/4" CHIP BOARD
NAIL SPACING	6" EXTERIOR/12" INT.	6" EXTERIOR/12" INT.	6" EXTERIOR/12" INT.	6" EXTERIOR/12" INT.
AIR BARRIER	6 MIL POLYETHYLENE	TYVEK	FOIL BACK GYPSUM BD.	N/A
VAPOUR BARRIER	6 MIL POLYETHYLENE	FOIL BACK GYPSUM BD.	FOIL BACK GYPSUM BD.	4 MIL POLYETHYLENE

FIGURE 5.3

WINDOW JOIST DETAIL

Morrison Hershfield Limited
Consulting Engineers



5.3.1 Panel 9 - Poly Approach

A "plywood wrap" method was used to maintain the plane of air-tightness around the window frame. This term is used because the plywood is attached and sealed with acoustic sealant to the outside of the window frame prior to installation of the assembly into the rough stud opening, essentially creating a second frame.

The polyethylene air barrier was then sealed directly to the plywood with acoustic sealant. 25 mm x 38 mm (1" x 2") pine was then nailed through the polyethylene to the plywood wrap, serving as a clamp for the joint and allowing for trim installation.

The plywood wrap requires a larger gross dimension for the window rough stud opening. The rough stud opening size for this panel was 1" larger in both directions than that of the other panels incorporating the window detail.

5.3.2 Panel 10 - EASE Approach

The window opening is the only detail of the three which interrupts the air barrier in the "EASE approach". The olefin membrane was wrapped around and sealed with acoustic sealant to the rough frame of the window opening. To maintain the plane of airtightness across the shim space (i.e. the gap between the window frame and the rough frame), one-part expanding urethane foam was injected into the space.

Once the urethane foam had cured, it was shaved to allow installation of the drywall and finishing trim.

5.3.3 Panel 11 - ADA Approach

To bridge the window frame shim space, this method uses a strip of "duct tape" between the window frame and the drywall. The finishing trim served to compress the duct tape against the drywall as well as protect it from damage. The space between window frame and rough frame was filled with fiberglass insulation.

5.3.4 Panel 12 - Traditional Approach

In this case, no special attention was given to sealing the window frame shim space against air leakage. The polyethylene vapour retarder was cut out of the rough stud opening, fiberglass was stuffed into the 125 mm shim space and window trim was installed to cover the shim space.

6. RESULTS AND COMMENTARY

Table 6.1 summarizes results of the testing program. It presents flow test results for all tests at two test pressures, 75 Pa and the maximum pressure tested. The maximum pressure tested was generally 1000 Pa but could be less for one of two reasons: The flow rate required to create 1000 Pa was greater than the capacity of the apparatus, or an obvious failure of the test panel developed.

Each of the following sections, which discuss findings on panels with the three construction details being evaluated, also includes a graphical presentation of results of tests on completed wall panels. These show results at intermediate pressure test points.

Complete graphic presentation of test results is given in Appendix B.

6.1 Header Joist Detail

Table 6.1 and Graphs 6.1 and 6.2 show the net flow rate per square meter of panel that was recorded at the specified pressure differences for panel No. 1 (POLY Approach), Panel No. 2, (EASE Approach), Panel No. 3 (ADA Approach) and Panel No. 4 (Traditional Approach).

Flow rates at 75 Pascals for Panel 1 and Panel 2 were about 24% and 18% respectively of the "Traditional" test section. The lowest leakage rates were achieved with Panel No. 3 (ADA). Its air flow at 75 Pa was about 10% of Panel No. 4 (Traditional). The air flow values and characteristics at 75 Pa, and lower pressure differences, are more meaningful than those at 1000 Pa in relation to moisture transfer and drying potential.

Panels 1 and 2 (POLY and EASE approaches respectively) both had relatively low leakage rates at the low pressure difference (75 Pa). The increase in the leakage rate of panel 1 (POLY) at the high pressure difference (1000 Pa) in the infiltration mode was about what would be anticipated. For a system with constant leakage characteristics (e.g. equivalent leakage area), the flow rate is proportional to the pressure difference to some power:

$$Q=C(\Delta p)^n$$

$$\text{Thus } Q_2= Q_1 (\Delta P_2/\Delta P_1)^n$$

TABLE 6.1 SUMMARY OF TEST RESULTS

Panel No.	Completion Stage	INFILTRATION MODE				EXFILTRATION MODE			
		flow @ 75 Pa l/s/sq. m.	max. press. Pa - note 1	flow @ max. P l/s/sq. m.	Failure Description	flow @ 75 Pa l/s/sq. m.	max. press. Pa - note 1	flow @ max. P l/s/sq. m.	Failure Description
HEADER DETAIL PANELS									
1 POLY	Exterior Sheathing insulation & poly. Gypsum complete	4.65	125	7.32	Maximum obtainable flow	5.34	100	7	Maximum obtainable flow
		too high	48	1.15	Failed acoustic seal along bottom plate	0.47	930	5.1	Poly pulled away from acoustic seal
		0.2	1000	1.6	No visible failure	0.25	900	4.3	Maximum obtainable flow
		0.24	1000	1.78	No visible failure	0.29	800	4.06	Maximum obtainable flow
2 EASE	Exterior A/B sheathing complete	0.2	1000	3.4	No visible failure	0.2	1000	3.74	No visible failure
		0.2	1000	3.15	No visible failure	0.2	1000	3.74	No visible failure
3 ADA	Exterior Sheathing insulation & gypsum complete	4.77	100	6.12	Maximum obtainable flow	5.1	125	6.2	Maximum obtainable flow
		0.1	1000	0.76	No visible failure	0.1	1000	0.85	No visible failure
		0.12	1000	0.76	No visible failure	0.12	1000	0.85	No visible failure
4 Traditional	Exterior sheathing insulation, poly. & gypsum complete	1.52	1000	7.3	No visible failure	1.44	1000	7.2	No visible failure
		1.13	1000	6.61	No visible failure	1.12	1000	6.45	No visible failure
		1.15	1000	6.5	No visible failure	1.12	1000	6.45	No visible failure
ELECTRIC OUTLET DETAIL PANELS									
5 POLY	Exterior sheathing insulation & poly. complete	too high	60	9.98	Maximum obtainable flow	too high	60	9.98	Maximum obtainable flow
		too high	30	0.65	Failed acoustic seal at poly pan	0.22	600	1.1	No visible failure
		0.014	800	1.07	No visible failure	0.14	1000	0.88	No visible failure
6 EASE	Exterior A/B Sheathing complete	0.2	1000	3.23	No visible failure	0.21	1000	3.65	No visible failure
		0.2	1000	3.1	No visible failure	0.2	1000	3.5	No visible failure
7 ADA	Exterior sheathing insulation, poly. & gypsum complete outlets covered with poly	too high	40	7.46	Maximum obtainable flow	too high	40	9.32	Maximum obtainable flow
		5.4	150	9.2	Maximum obtainable flow	5.5	150	9.7	Maximum obtainable flow
		2.5	500	8.2	Maximum obtainable flow	2.6	500	8.4	Maximum obtainable flow
		0.2	1000	2.58	Duct tape pulled away from Gypsum	0.35	1000	1.29	No visible failure
8 Traditional	Exterior sheathing complete	0.63	1000	3.8	No visible failure	0.63	1000	3.5	No visible failure
		0.54	1000	3.5	No visible failure	0.54	1000	3.6	No visible failure
WINDOW DETAIL PANELS									
9 POLY	ext. sheathing, insulation & poly complete	2.14	100	3.15	Failed acoustic seal at sill wrap	0.37	1000	1.15	No visible failure
		0.2	1000	1	No visible failure	0.29	1000	1.98	No visible failure
10 EASE	Exterior A/B sheathing & foam complete	0.24	1000	3.32	No visible failure	0.24	1000	3.06	No visible failure
		0.24	1000	2.95	No visible failure	0.25	1000	3.15	No visible failure
11 ADA	ext. sheath., insul & drywall complete	too high	25	3.18	No visible failure	too high	25	3.27	Maximum obtainable flow
		too low	1000	0.35	No visible failure	too low	800	0.24	No visible failure
12 Traditional	complete except trim complete	3	200	6.53	Maximum obtainable flow	2.47	300	7.79	Maximum obtainable flow
		2.47	300	7.17	Maximum obtainable flow	1.87	500	7.47	Maximum obtainable flow

- NOTES: - "max. press." refers to the maximum pressure difference achieved in test. It could be governed by a failure, the limit of the flow capacity of the test apparatus, or by design (at 1000 Pa).
- the term "too high" means the test apparatus could not create a 75 Pa pressure difference.
- the term "too low" means the flow rate was below measurable levels with the instrumentation used.

HEADER JOIST DETAIL COMPLETED PANEL

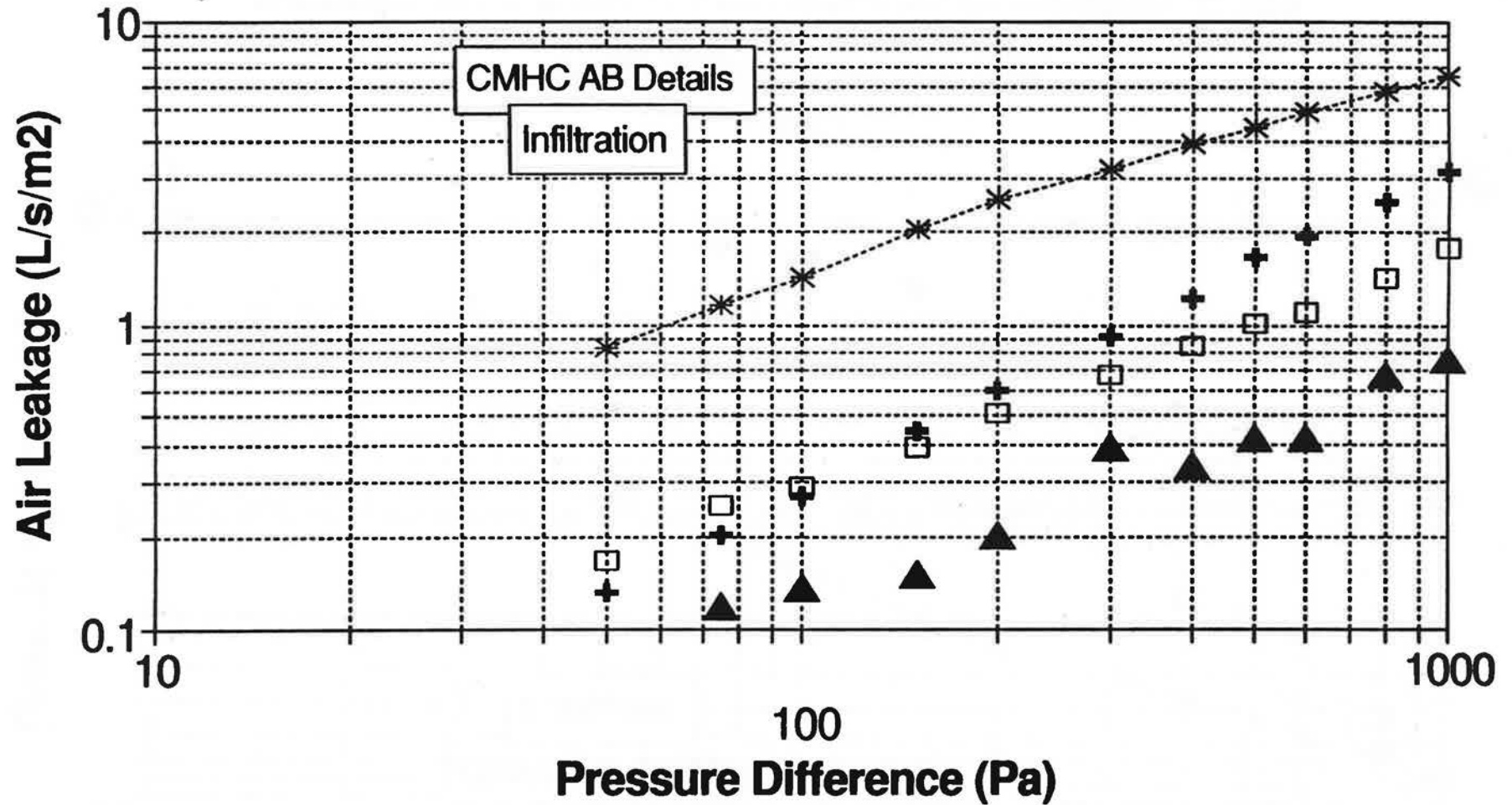

□ POLY, panel 1
 + EASE, panel 2
 ▲ ADA, panel 3
 -* Traditional, panel 4

Graph 6.1

HEADER JOIST DETAIL COMPLETED PANEL

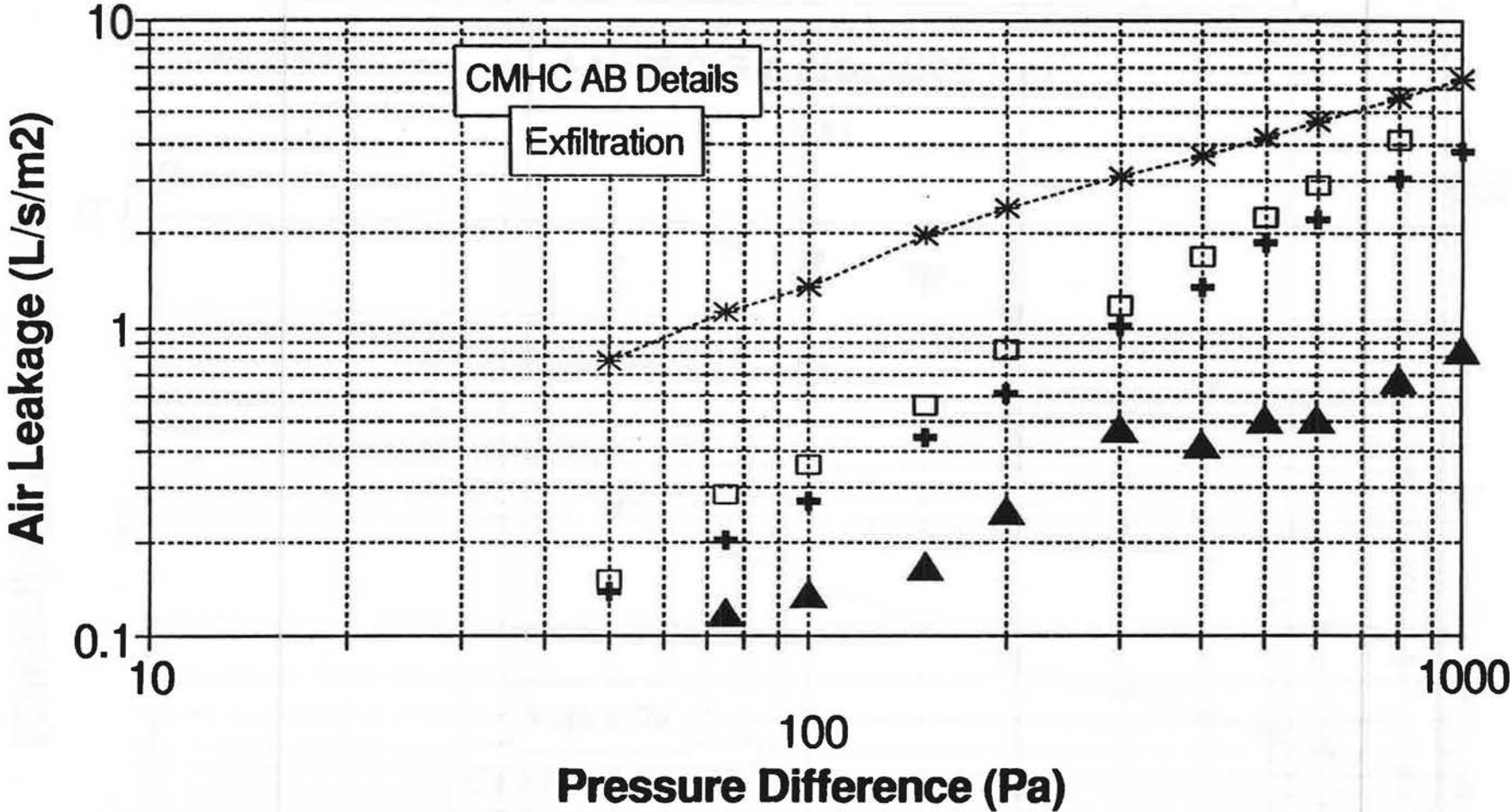

□ POLY, Panel 1
+ EASE, Panel 2
▲ ADA, Panel 3
-* Traditional, Panel 4

Graph 6.2

For panel 1 in the infiltration mode:

$$1.78 = 0.24 (1000/75)^n$$

This corresponds to a value for n of 0.77, which seems reasonable for a system with very small leakage paths. Applying this exponent to extrapolating the results for panel 1 in the exfiltration mode gives a value of 1.92 l/s.m² at 1000 Pa instead of the measured value of 4.06 l/s.m². In fact, the maximum theoretical value of n is 1, which would give a value of 3/1 l/s.m² at 1000 Pa. It must be concluded, therefore, that the equivalent leakage area of the leakage paths for panel 1 increased at the 1000 Pa pressure difference.

A plausible explanation is that the Tyvek, which wraps around the exterior of the header joist in panel 1, to provide an airtightness at this detail, had only the support of the semi-rigid glass fibre sheathing in the exfiltration mode. Under exfiltration a ballooning affect can be expected. When the membrane expands away from the header, the full surface area is available for the air to diffuse through. Under infiltration, the membrane will be forced against the header, limiting the effective diffusion area (one can think of this as similar to a valve action.) This ballooning affect might also lead to damage of the membrane after repeated loading.

A similar analysis of the results for panel 2 (EASE approach) indicates that there was a similar increase in the equivalent leakage area (ELA) of the complete panel in both the infiltration and exfiltration modes at the high (1000 Pa) pressure difference. It seems likely that the pressure difference across the Tyvek - fibreboard sheathing sandwich caused separation of the fiberboard layers. Because most of the pressure drop would occur across the Tyvek, the inner layer of fibreboard would bow inward in the infiltration mode and open a gap between the Tyvek and the outer layer. The opposite would happen in the exfiltration mode. Thus infiltrating and exfiltrating air would be distributed more uniformly over the full area of the Tyvek. At low pressure differences there would be no such gaps and there would be substantial resistance to lateral air flow in the plane of the Tyvek. At the high pressure difference, the overall leakage rate was slightly higher in the exfiltration mode. This may have been because there was little bowing of the sheathing over the heater area in the infiltration mode. These effects may not be significant in practice, since overall pressure

differences across house walls in most locations would be less than 75 Pa most of the time.

The leakage rates for panel 2, before the gypsum wall board was applied, were the same as for the complete panel at 75 Pa and only slightly greater than for the complete panel at 1000 Pa pressure difference. Thus, the gypsum board contributed very little to the airtightness of the completed panel.

During the precompletion test sequences, only Panel No. 1 exhibited signs of failure. This occurred in the infiltration mode testing at a pressure difference of 50 Pa. An acoustic sealant joint between polyethylene and olefin membrane opened up. The failure was repaired prior to proceeding with construction. This illustrates the sensitivity of this approach to wind loading in the incomplete condition. One concern with this type of construction which warrants further investigation is whether such seal failures are corrected by the clamping action of drywall installation.

It is apparent from the results for panel 1 with exterior sheathing only, that the glass fibre sheathing offered very little resistance to air flow. This is apparent also from the results with panel 3. On the other hand, results for panel 4 (Traditional) indicate that the chipboard sheathing provided most of the air flow resistance.

6.2 Electrical Outlets

Table 6.1 and Graphs 6.3 and 6.4 show the net flow rate per square meter of panel that was recorded at the specified pressure differences for panel No. 5 (Poly Approach), Panel No. 6, (Ease Approach), Panel No. 7 (ADA Approach) and Panel No. 8 (Traditional Approach).

Panel No. 5 (POLY) was the tightest of the four. Results given in Table 6.1 for the complete panel are those without cover plates. The results with cover plates in the exfiltration mode are anomalous, in that they indicate a noticeable increase in leakage at all pressure differences (see graph 14). It is thought that some movement of sealant (e.g. around electrical wires entering the poly pan) may have taken place prior to the initiation of this test sequence. In the test series prior to installation of the gypsum board, there was a failure of the acoustical sealant joint between the

ELECTRICAL OUTLET DETAIL

COMPLETED PANELS

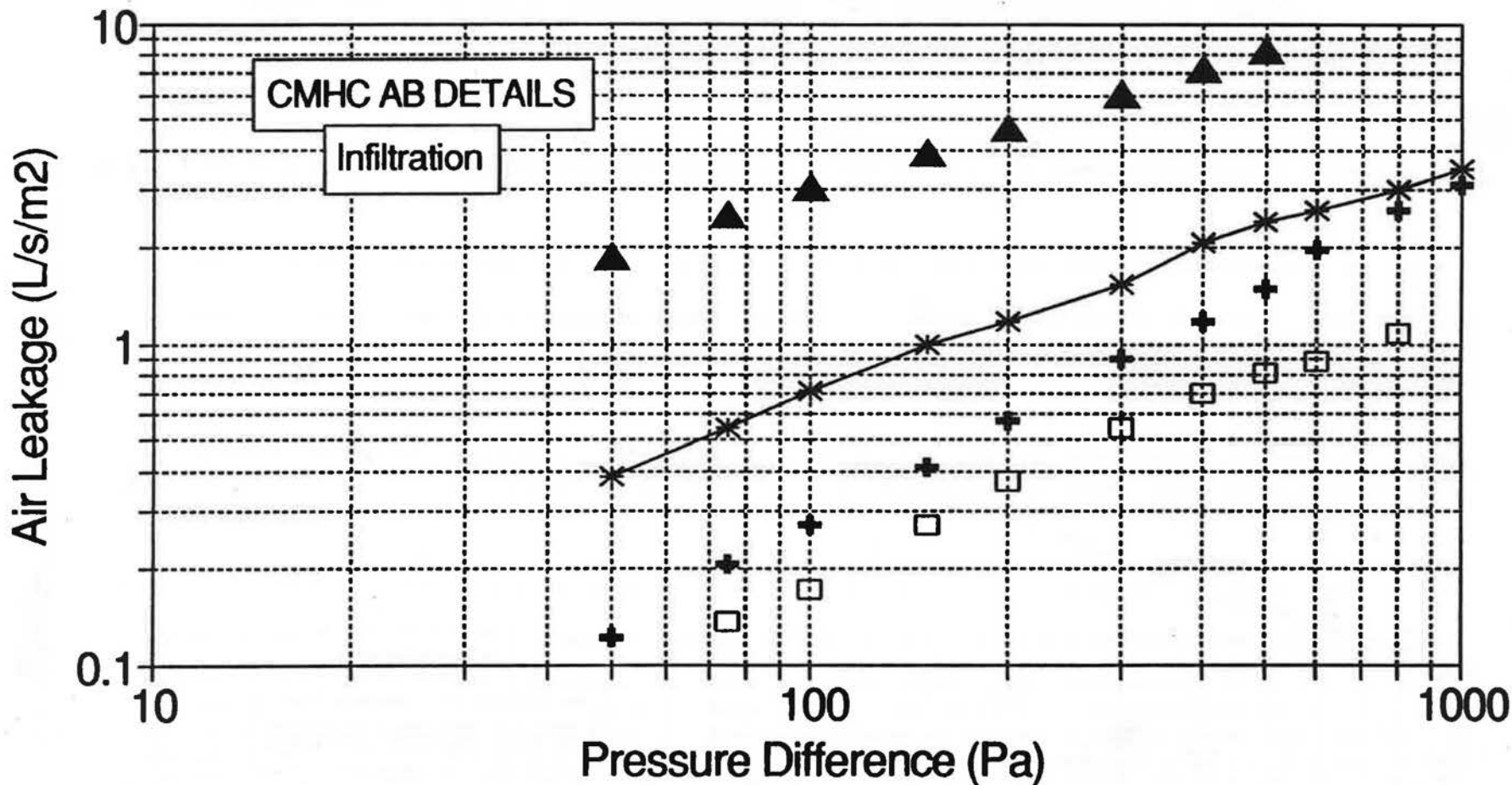

Graph 6.3

ELECTRICAL OUTLET DETAIL

COMPLETED PANELS

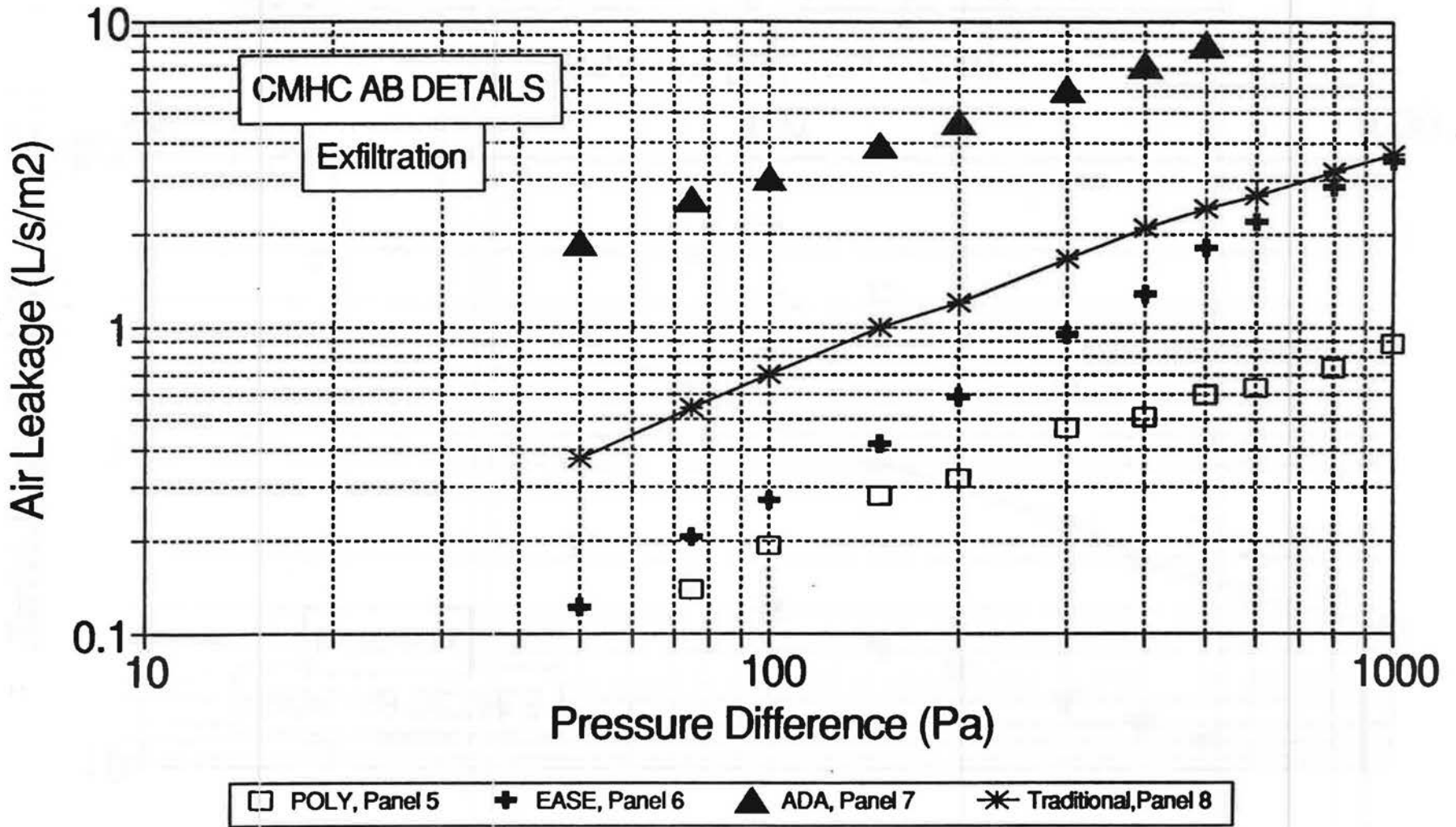

Graph 6.4

polyethylene film and the poly pan in the infiltration mode at a pressure difference of 30 Pa. This is equivalent to the velocity head of a wind at 7.1 m/s (16 mph).

Panel 6 (EASE) also exhibited quite high resistance to leakage at the low (75 Pa) pressure difference. There was an apparent increase in equivalent leakage area at the high (1000 Pa) pressure difference, similar to that exhibited by panel 2. It is postulated that the cause was the bowing of the fibreboard sheathing as discussed with respect to panel 2. It seems likely that panel 6 derived most of its resistance to flow from the fibreboard - Tyvek sandwich. This is supported by the results of the test sequence with exterior A/B sheathing only, which indicate leakage values only slightly higher than those of the complete panel. Thus the leakage rate for the fibreboard - Tyvek sandwich is about 0.2 l/s.m² at 75 Pa. With bowing and separation of the fibreboard at 1000 Pa, the sandwich offers less flow resistance. Extrapolating the leakage value at 1000 Pa (e.g. 3.3 l/s.m²) to that for a pressure difference of 75 Pa, assuming an exponent of 0.75, gives a value of 0.47 l/s.m². This may approximate the value for the Tyvek alone.

Panel 7 (ADA approach) shows little flow resistance in the complete condition. Leakage is associated primarily with the gaps around the electrical boxes. This is confirmed by the results of an additional test sequence, shown in Table 6.1, with polyethylene, sealed to the gypsum board with duct tape, covering the outlets. This brought the overall leakage value at 75 Pa down to that for panel 6.

Panel 8 (Traditional approach) had a higher resistance to flow than panel 7. The flow values for the test sequence with exterior sheathing only were only slightly higher than those for the completed panel, indicating that there was little resistance to flow past the electrical boxes, and that the sheathing provided the primary flow resistance. The air leakage value for the chipboard sheathing of panel 8 is apparently about 0.6 l/s.m² at 75 Pa; the corresponding value for panel 4 is 1.4 l/s.m². The differences are assumed to be due to variations in the leakage characteristics of the chipboard and to differences in the leakage through nail holes and edges.

6.3 Window Detail

Table 6.1 and Graphs 6.5 and 6.6 show the net flow rate per square meter of panel that was recorded at the specified pressure difference for panel No. 9 (Poly

WINDOW DETAIL COMPLETED PANELS

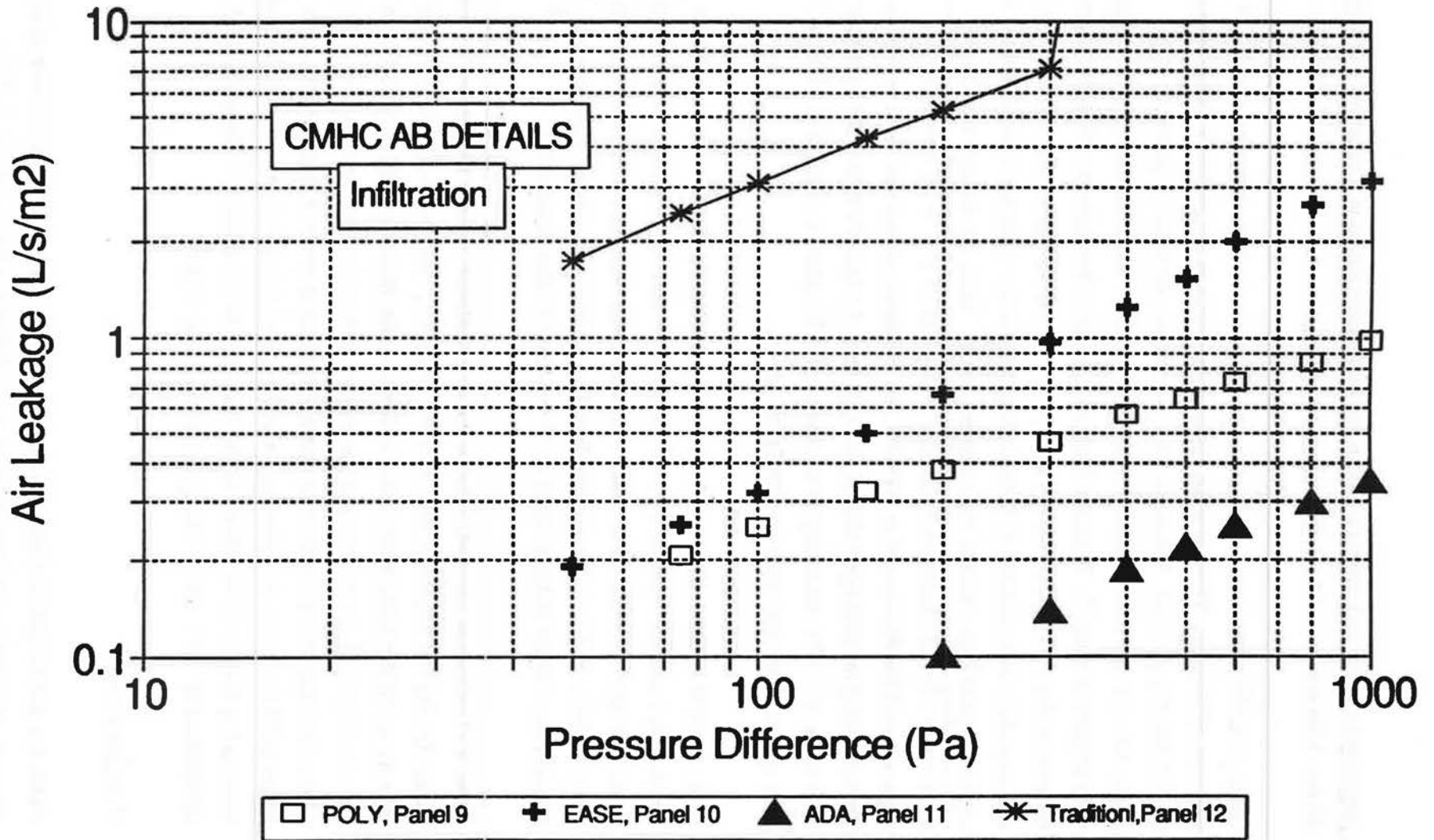

Graph 5.5

WINDOW DETAIL COMPLETED PANELS

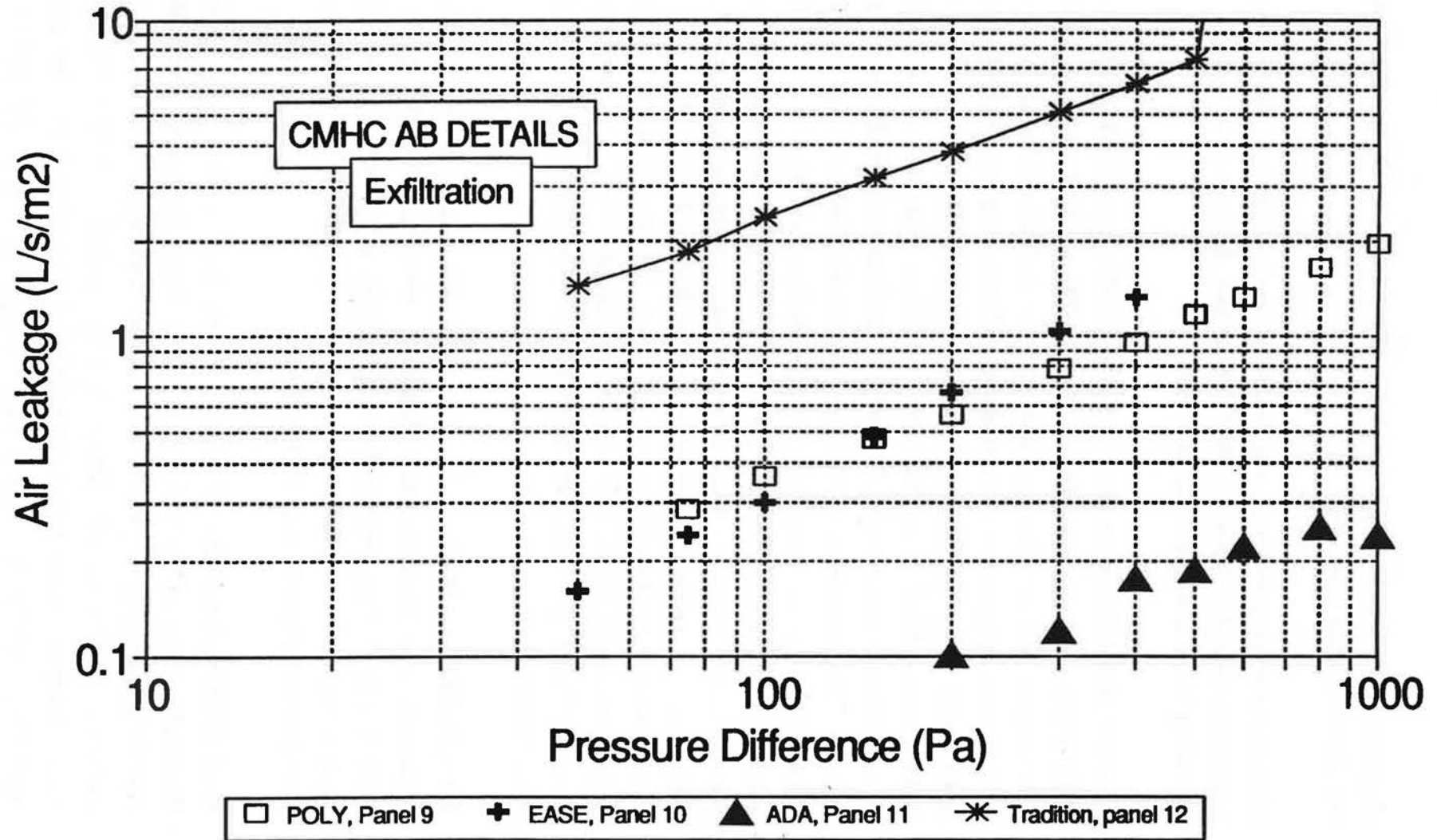

Graph 6.6

Approach), Panel No. 10, (Ease Approach), Panel No. 11 (ADA Approach) and Panel No. 12 (Traditional Approach).

Measured leakage at 75 Pascals was lowest for panel 11 (ADA). Values were comparable for panels 9 and 10 (POLY and EASE). All were no more than 15% of the values for the traditional section.

Panel No. 10 (EASE approach) and Panel No. 9 (POLY approach) had similar leakage rates under lower pressure conditions but Panel 10 became considerably more air permeable at higher pressures. This characteristic of the fibreboard - Tyvek sandwich was noted in connection with panels 2 and 6. An estimate of the leakage rate through the window detail at 75 Pa can be made for panel 10 based on a leakage rate for the fibreboard - Tyvek sandwich of 0.2 l/s.m² (from panel 6). When the area of the window is accounted for, the total leakage through the window detail is 0.28 l/s at 75 Pa. This is equivalent to 0.27 m³/h per meter of perimeter length of the shim space. The maximum allowable air leakage rate for a fixed window in CSA Standard A440-M90 is 0.25 m³/h per meter of window perimeter. Thus, the shim space for panel 10 is relatively tight. A similar analysis can't be made for panel 9 (POLY) because it is not possible to separate the leakage through the shim space from that through the rest of the panel. It seems likely, however, that the leakage through the polyethylene air barrier was less than that through the fibreboard - Tyvek sandwich of panel 10. This suggests then, that the window detail in panel 9 had a higher leakage rate at 75 Pa than that of panel 10.

We again found that the Poly approach was susceptible to damage of the acoustic sealant joint prior to installation of the drywall, where failure occurred in the infiltration mode at a pressure difference of 100 Pa. We found that the corners of the window frame, where the polyethylene has been cut at a 45° angle, is the most likely the location for a gap to occur (Photo 10).

Panel 11 (ADA Approach) uses "duct tape" (as suggested by a builder) to maintain the integrity of the air barrier across the window frame shim space. This worked effectively, providing very low flows under both positive and negative pressure differences (exfiltration and infiltration). Very high leakage rates were obtained with the test sequence before the tape was installed. One can question the long term durability of the tape and adhesive, as it is subjected to cold, hot and sometimes damp

conditions. This panel may warrant further tests in the future to see if the integrity of the air seal has been maintained.

Results for panel 12 (Traditional approach) indicate a very high leakage rate for the window detail. Results for panel 8 suggest that the leakage through the wall area covered with chipboard sheathing and gypsum could have fallen between 0.51 and 1.1 l/s.m² at 75 Pa (it might also have been higher due to the increase in length of exposed edges of the sheathing around windows). This translates into a leakage through the window detail (average of infiltration and exfiltration) of between 4.8 and 3.5 l/s, or between 4.6 and 3.4 m³/h per meter of shim space perimeter. By way of comparison, CSA Standard A440-M90 specifies a maximum leakage rate of 2.79 m³/h for the most leaky class of openable window.

7. DISCUSSION

7.1 Overall Air Leakage

There are not yet standards that define tolerable levels of air leakage though the construction details of wall systems evaluated in this study. There are, however, some bench-mark numbers to which our results can be compared.

- Lux and Brown of NRC suggested in a paper presentation at Building Insight 1986, that walls be restricted to 0.05, 0.1 or 0.15 l/s/m² @ 75 Pa for buildings that have an RH. value above 55% (TYPE 3), between 27% and 55% (Type 2) or below 27% (Type 1) respectively. Residential buildings would fall into the 0.1 l/s/m² @ 75 Pa category.
- The American Architectural Manufacturers Association (AAMA) allows a total airflow of 0.3 l/s/m² @ 75 Pa for glass and aluminum curtain walls.
- The R-2000 Program requires that the equivalent leakage area of the envelope assembly, including intentional openings, penetrations, etc., not exceed .7 cm²/m² (in addition there is a limit on the air change per hour @ 50 Pa due to envelope leakage). This equivalent leakage area can be converted to a flow rate per m² at 10 Pa pressure difference with the equation:

$$Q_{10}(l/s) = 788 \text{ ELA}(m^2) (10)^{1/2}$$

The flow rate m² at 75 Pa is then:

$$Q_{75}(l/s) = Q_{10}(7.5)^n$$

Using a value for n of 0.65 gives a flow of about 0.64 l/s/m² @ 75 Pa.

- Recent airtightness testing in current tract built construction has shown average leakage characteristics of more than double this value (e.g. 1.4 l/s/m² @ 75 Pascals).

The above numbers define leakage rates based on the overall envelope area. Our test panels had very high ratio of joint or penetration to wall area. Even so, when

comparing our results (summarized in Table 6.1) to the above bench-mark numbers, one would only characterize the "Traditional" construction test sections and Panel 7 (ADA electrical outlets) as leaky. All others met the AAMA standard. Only one however, Panel No. 11 (ADA windows), met the NRC suggested level of 0.1 l/s/m^2 @ 75 Pascals. The other two come close if divided by two to account for typical window perimeter/ m^2 of wall.

We found that those sections that relied on the use of the spun bonded olefin membrane as a significant component of the air barrier system were limited in their potential level of impermeability. This is not surprising since previous testing by CMHC has shown that the material itself has a permeability to air flow which allows a leakage rate of approximately $.3$ to $.4 \text{ l/sec.m}^2$ @ 75 Pascals.

Our test panels which used the fibreboard / olefin membrane / fibreboard sandwich air barrier system (EASE) had air permeabilities that were approximately 50% of this value. This would appear to be the basic limit of the assembly since in some of the test panels the air barrier assembly was uninterrupted. It would be possible to increase the resistance to air flow by using more layers of the membrane.

The low air permeability of polyethylene and drywall potentially provides greater levels of airtightness but only if joints are made in an airtight manner. Since the water vapour permeance of these materials requires that they be located on the indoor side of the insulation, there will be more joints to deal with, than with the fibreboard - Tyvek sandwich air barrier.

Another way of looking at the results is to consider the contribution these construction details could make to overall house leakage. Table 7.1 provides the leakage values for each panel in terms of the unit length or the number of detail elements.

TABLE 7.1
FLOW RATE AT ±75 Pa

	HEADER JOIST L/S/M DETAIL	ELECTRICAL OUTLET (L/S/ELEC.BOX)	WINDOW DETAIL (L/S/M)
POLY APPROACH	0.05	0.02	0.07
EASE APPROACH	0.039	0.03	0.062
ADA APPROACH	0.022	0.38	0.008
TRAD APPROACH	0.22	0.085	0.6

The values given in Table 7.1 reflect the leakage through the detail assuming all the air flow is directed via the detail. This of course is not the case since air will also permeate through the various sheathing materials, particularly where spun bonded olefin is defined as the prime air barrier. This has been noted in the presentation of the results. For example, the leakage rate for the EASE window detail could be 0.073 l/s.m, and that for the traditional window detail could be between 0.92 and 1.3 l/s.m.

One can use the numbers in Table 7.1 to make a rough estimate of how much the details contribute to the overall leakage of a house.

A 150 m² (1,600 ft²) 2 storey house with basement and outside plan dimensions of 7.5 m x 10 m could have a volume of about 560 m³, approximately 70 m of header joist, 15 electrical outlets in exterior walls and about 40 m of window perimeter.

The standard airtightness test method for houses quotes results in air change per hour @ 50 Pa. Recent studies have indicated that new houses average about 3 to 4 AC/h @ 50 Pascals. R-2000 houses must be below 1.5 AC/h. Most are around .8 AC/h @ 50 Pa.

The flow through envelope leakage paths at 50 Pascals will be about 75% of the flow at 75 Pascals so we can convert the values from Table 7.1 into AC/hr figures with the above assumptions, using the equation:

$$AC/h @ 50 = \frac{L/S \text{ per unit @ } 75 \times \text{area of units} \times 75\%}{\text{house volume}} \times 3.6$$

This is done in Table 7.2.

TABLE 7.2
CONTRIBUTION OF THE DETAILS TO
TOTAL AIR LEAKAGE OF EXAMPLE HOUSE

	HEADER JOIST (70 m) A.C. per hour	15 ELECTRICAL OUTLETS A.C. per hour	WINDOWS (40 m) A.C. per hour	TOTAL
POLY APPROACH	0.0168	0.0014	0.0135	0.0317
EASE APPROACH	0.0132	0.0022	0.0120	0.0274
ADA APPROACH	0.0074	0.0275	0.0015	0.0364
TRADITIONAL APPROACH	0.0743	0.0062	0.1157	0.1962

One may be struck with how small the calculated air leakage numbers are but must be careful not to conclude that they are insignificant. Our test panels had good quality control so probably have lower leakage values than similar details in houses. Secondly, the potential for problems due to a leak in a confined area such as a joint detail may be much greater than its proportion of total leakage.

It is worth noting that the total leakage calculated for each of the sealing approaches are all less than 20% of the Traditional approach where no specific efforts at sealing were made.

7.2 Air Leakage at Details

One must also recognize that the specific sealing details used are not the only ones that could be used with a particular construction method nor are they exclusive to the method. For example, sealing the window frame "shim space" with foam insulation could be done with any of the construction approaches. There are also products and methods for sealing electrical boxes in the ADA approach which are functionally similar to how the "Poly Approach" detail was dealt with.

The results of our testing indicated that any of the three quite different methods providing a continuous air barrier could produce significant improvement to the airtightness of the specific details tested. It would appear practical to build tight houses (which would meet the R-2000 test standards of 1.5 air changes per hour) with any of them.

Our testing showed that the gasket approach to sealing framing joints, used in the ADA panels, worked very well. This should be true if the gap between elements is limited by careful construction, as it was with our test panels.

Our POLY header test section was not as tight but we found evidence that much of the leakage was due to the permeability of the spun bonded olefin membrane header wrap rather than the joint seals themselves. Our testing also showed how important it is to locate the joints in a place where the caulking is clamped between rigid structural members. The completed test panels were capable of withstanding high loads such as wind forces, but prior to being clamped by the drywall the joints, were relatively fragile.

The EASE approach does not require sealing of the framing joints.

Our testing showed that, of the details we tested, the largest potential for increasing airtightness, compared to traditional construction methods, is to improve the sealing around the window frames. Our testing used three different methods to seal the shim space around a window, the plywood wrap system with the poly approach, a tape joint for the ADA approach, and spray-in-place foam for the EASE approach. They were all quite effective in controlling air leakage around the window, but the tape approach and spray in place foam appeared to provide the tightest connection. These methods could of course be applied to different construction methods than those which were tested.

In test panel No. 11, duct tape was used to form the seal around the window . This was based on the suggestion of a builder and it certainly worked well. We are not aware of any testing that establishes the durability of this material and it's adhesive in this application.

Our testing of interior electrical outlet sealing methods showed that the face plate gasket approach to sealing these penetrations was not a substitute for having a sealed electrical box or sealing methods such as "Poly Pan". They did however, make a significant improvement of unsealed electrical boxes and should be recommended as a relatively simple way of reducing air leakage through electrical outlets in existing houses.

7.3 Structural Performance

An air barrier system must be able to support the structural loads placed upon it. We had only one complete test panel which had indications of a failure during structural load testing. This was Panel No. 5 (POLY Electrical Outlets) which showed a slight increase in leakage after testing at high pressures (about 700 Pa). Even then it was tighter than the competing systems. The structural performance of the test panels indicates that it is possible to build structurally adequate (at least for low rise buildings) air barrier systems using any of the three approaches but it is more difficult when using the poly approach.

A disadvantage of the poly approach is that it will be more susceptible to wind damage during construction. The system relies on the interior sheathing for both support and mechanical clamping of acoustic sealant joints. We had joints open up during precompletion testing at pressures as low as 30 Pa. In our test panels, these failures were corrected prior to drywall installation and we noted that, because of locations selected for the joints, the clamping action of the drywall installation may have sealed the joints in any case. Whether these hold true in the field is debatable.

The test program undertaken in this project is, in reality, only the first step to define the air leakage characteristics of air barrier connection details and methods of sealing penetrations through air barriers.

The program dealt with a relatively limited number of details and did not address some other very important factors such as the significance of imperfections in the construction or long term durability of the sealing methods used. The methodology developed for this project could be applied to the testing of virtually any construction detail with or without construction imperfections. Durability issues can at least be

partially addressed by pressure cycling testing and by retesting after exposing test panels to conditions which could deteriorate the sealing assemblies.

7.4 Issues for Further Study

Some of the issues that arise from consideration of the results of this study are as follows:

1. Little consideration has been given in the past to defining adequate limits for air leakage for construction details of residential envelopes. Some overall limits for envelopes have been established for the R-2000 program, but this includes leakage through all penetrations, including windows and doors. Limits have been established for windows, but not for the construction details surrounding windows. It would be useful to establish realistic airtightness guidelines for different components of residential envelopes.
2. Failure of the acoustic sealant joint in the POLY test panels prior to installation of the gypsum wall board occurred in the infiltration mode at relatively low pressure differences. Depending upon the design of the acoustic sealant joint, the seal may be re-established when the joint is clamped by application of the wall board. The probability of permanent damage to acoustic sealant joints of the POLY approach, due to wind action during construction, requires further evaluation. This includes consideration of design details for the joints, including over-laps and clamping pressures, to minimize the possibility of permanent damage.
3. Some of the approaches employed tapes and gaskets to achieve airtightness. Standards to ensure the durability of these components over their anticipated service life require consideration.
4. The ADA approach requires the use of gaskets between rigid components. The effectiveness of the seal achieved will depend on the size of the gaps, the dimensions and rheological properties of the gaskets, and the pressures applied to the gaskets. Some guidelines relating to construction tolerances, dimensions and properties of gaskets, and clamping, would be helpful.

5. **The airtightness of the EASE approach depends largely on the air permeability of the olefin membrane. Some requirements for maximum allowable air permeability of the membrane are needed.**

6. **The test panels were carefully assembled under laboratory conditions. The effectiveness of air barrier systems as constructed under field conditions requires further assessment.**

8. CONCLUSION

1. All three of the "sealed" construction methods evaluated could be used to construct relative tight envelopes such as required by the R-2000 standards (1.5 air changes per hour at 50 Pa).
2. When a single layer of spun bonded olefin membrane is used as an air barrier, there is a lower limit to the air leakage resistance attainable. In test sections where it formed the entire and uninterrupted air barrier (sandwiched between fiberboard in the EASE test sections), overall air leakage rates were approximately .2 l/s/m².
3. While all completed test panels perform adequately in structural testing at 1000 Pa pressure difference, the poly system appeared most susceptible to damage under high pressure. It is particularly susceptible to damage prior to the installation of drywall which provides structural support and mechanical clamping of joint seals.
4. The gasket joints of the ADA approach provided the best test results for header detail sections. The other equivalent sections relied on spun bonded olefin to seal the header area (see Item 1 above).
5. Electrical base plate gaskets proved to be a relatively poor way of sealing electrical boxes when compared to a sealed box system like the poly pan. The gaskets did, however, reduce flows by approximately half so they may have merits in retrofit situations.
6. The duct type seal of the window shim space on the ADA approach test panel and the single part urethane foam injection system used on the EASE panel provide very good sealing of the window shim space.

7. Our test program address the performance of newly constructed test sections. It did not specifically address durability issues. This is a very important criteria which should be addressed in future work.

MORRISON HERSHFIELD LIMITED



A handwritten signature in black ink, appearing to read "Mark Lawton", written over a horizontal line.

Mark Lawton, P.Eng.

A handwritten signature in black ink, appearing to read "R.L. Quirouette", written over a horizontal line.

R.L. Quirouette, B.Arch.

APPENDIX A

Description Level of Construction For Each Test Sequence

APPENDIX A
DESCRIPTION LEVEL OF CONSTRUCTION FOR EACH TEST SEQUENCE

HEADER JOIST DETAIL

	SEQUENCE 1	SEQUENCE 2	SEQUENCE 3	SEQUENCE 4
Panel 1 Poly Approach	Test after exterior sheathing is in place	Test after sheathing, insulation and polyethylene installed	Exterior sheathing, insulation, polyethylene, drywall	Completed wall with trim installed
Panel 2 EASE Approach	Exterior sheathing	Exterior sheathing, insulation, drywall and trim	N/A	N/A
Panel 3 ADA Approach	Exterior sheathing	Exterior sheathing, insulation, drywall	Exterior sheathing, insulation, drywall, trim	N/A
Panel 4 Traditional Approach	Exterior sheathing	Exterior sheathing, insulation and drywall	Exterior sheathing, insulation, polyethylene, drywall, trim	N/A

APPENDIX A
DESCRIPTION LEVEL OF CONSTRUCTION FOR EACH TEST SEQUENCE

ELECTRICAL OUTLET DETAIL

	SEQUENCE 1	SEQUENCE 2	SEQUENCE 3	SEQUENCE 4
Panel 5 Poly Approach	Exterior sheathing	Exterior sheathing insulation polyethylene	Drywall installed	N/A
Panel 6 EASE Approach	Exterior sheathing	Completed wall with cover plates	N/A	N/A
Panel 7 ADA Approach	Exterior sheathing	Exterior sheathing, insulation and drywall	Insulation, drywall, trim, electrical cover plate and gasket	Cover electrical outlets with poly
Panel 8 Traditional Approach	Exterior sheathing	Exterior sheathing, polyethylene and drywall	Add cover plate and trim	N/A

**APPENDIX A
DESCRIPTION LEVEL OF CONSTRUCTION FOR EACH TEST SEQUENCE**

WINDOW DETAIL

	SEQUENCE 1	SEQUENCE 2	SEQUENCE 3	SEQUENCE 4
Panel 9 Poly Approach	Exterior sheathing, insulation, Polyethylene	Drywall installed, trim installed	Cover window with Polyethylene	N/A
Panel 10 EASE Approach	Exterior sheathing, urethane foam around shim space	Completed wall	N/A	N/A
Panel 11 ADA Approach	Exterior sheathing insulation drywall	Duct-tape around shim space, trim installed	N/A	N/A
Panel 12 Traditional Approach	Exterior sheathing insulation poly drywall	Trim installed, Completed wall	N/A	N/A

APPENDIX B
Graphic Test Results

HEADER JOIST DETAIL POLY APPROACH

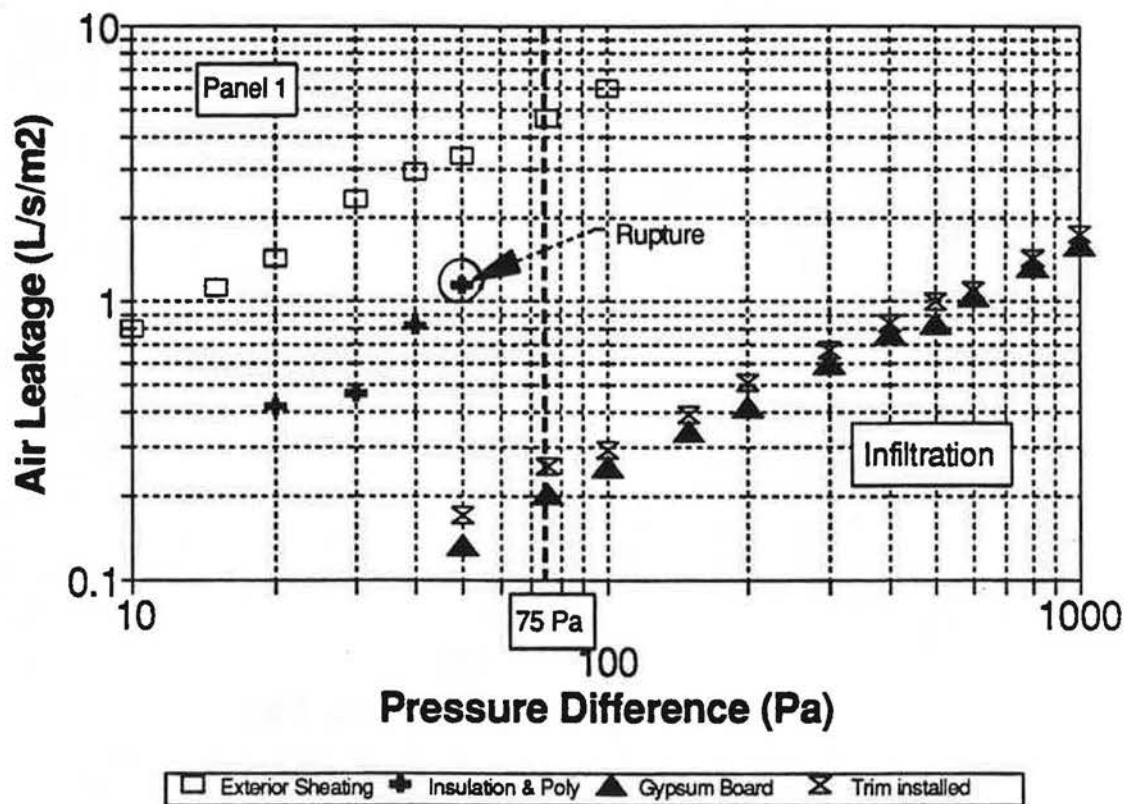

Graph 1

HEADER JOIST DETAIL POLY APPROACH

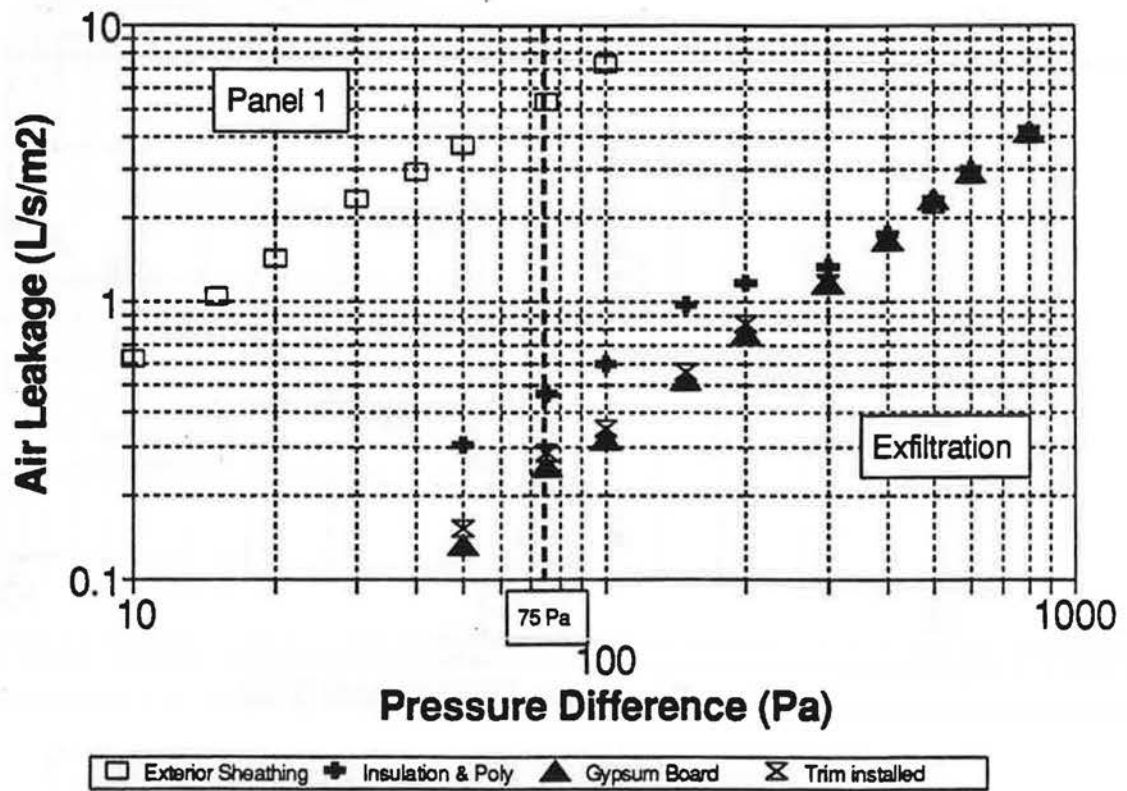

Graph 2

HEADER JOIST DETAIL POLY APPROACH

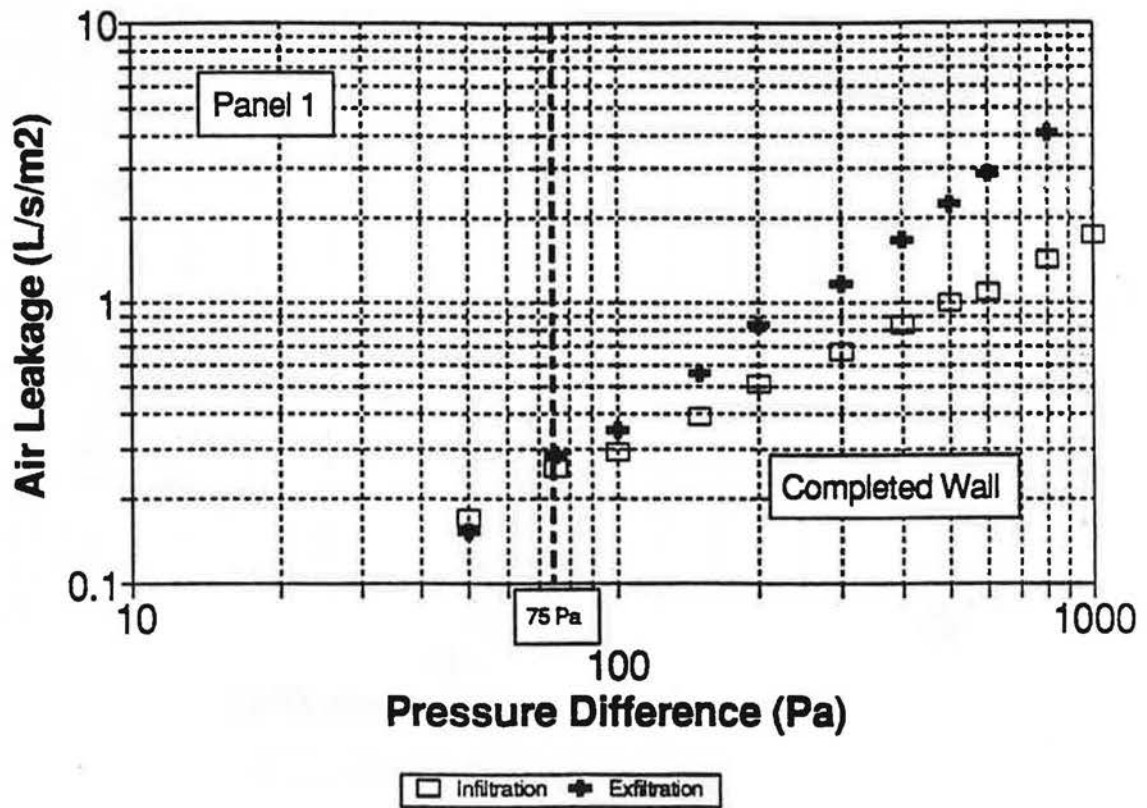

Graph 3

HEADER JOIST DETAIL EASE APPROACH

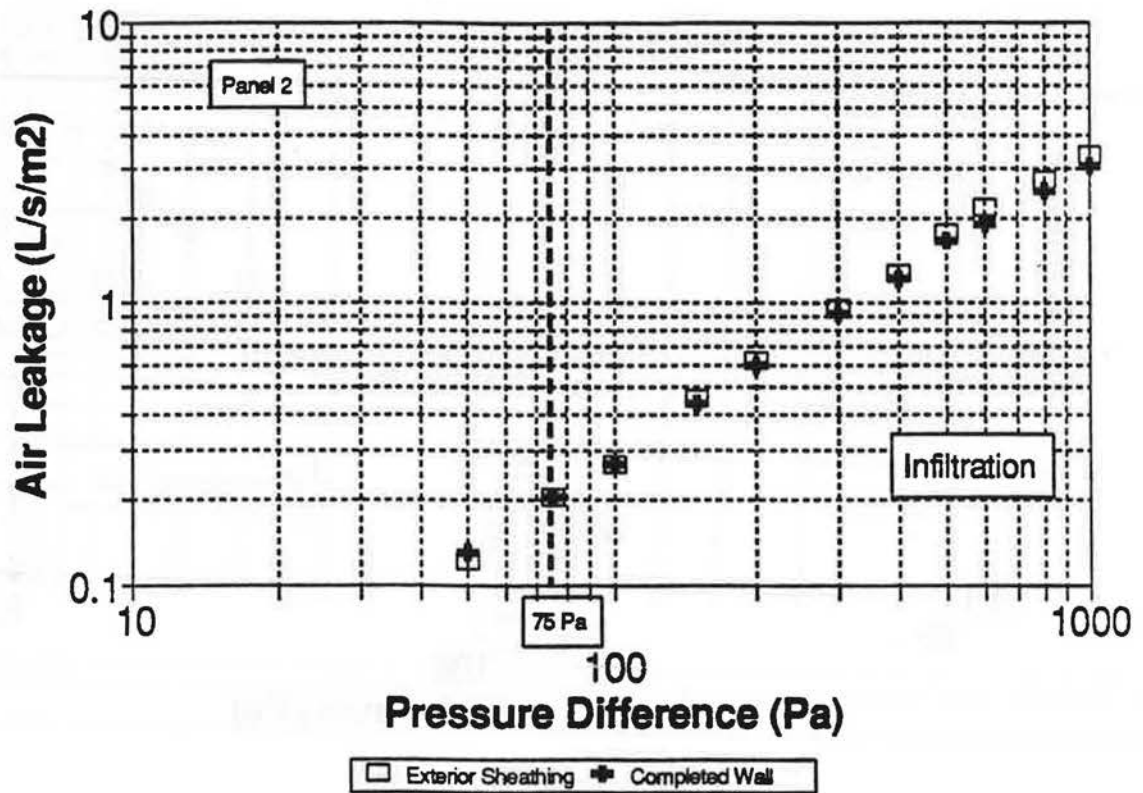

Graph 4

HEADER JOIST DETAIL EASE APPROACH

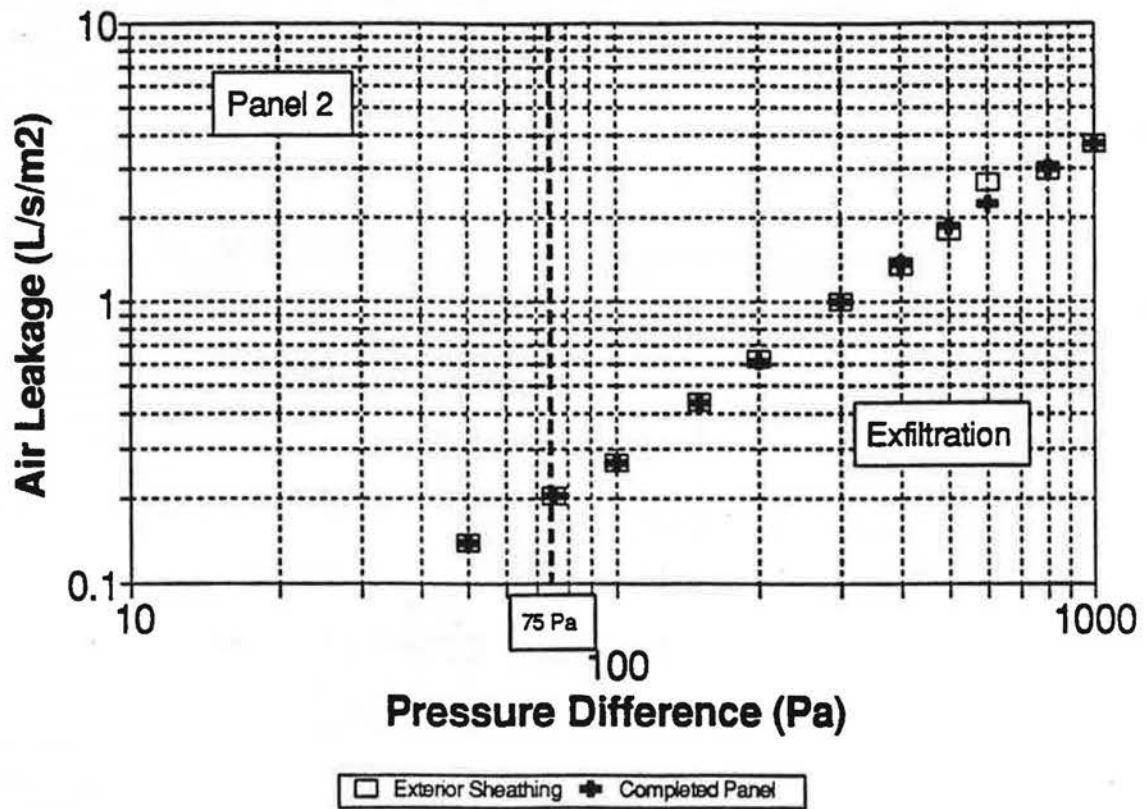

Graph 5

HEADER JOIST DETAIL EASE APPROACH

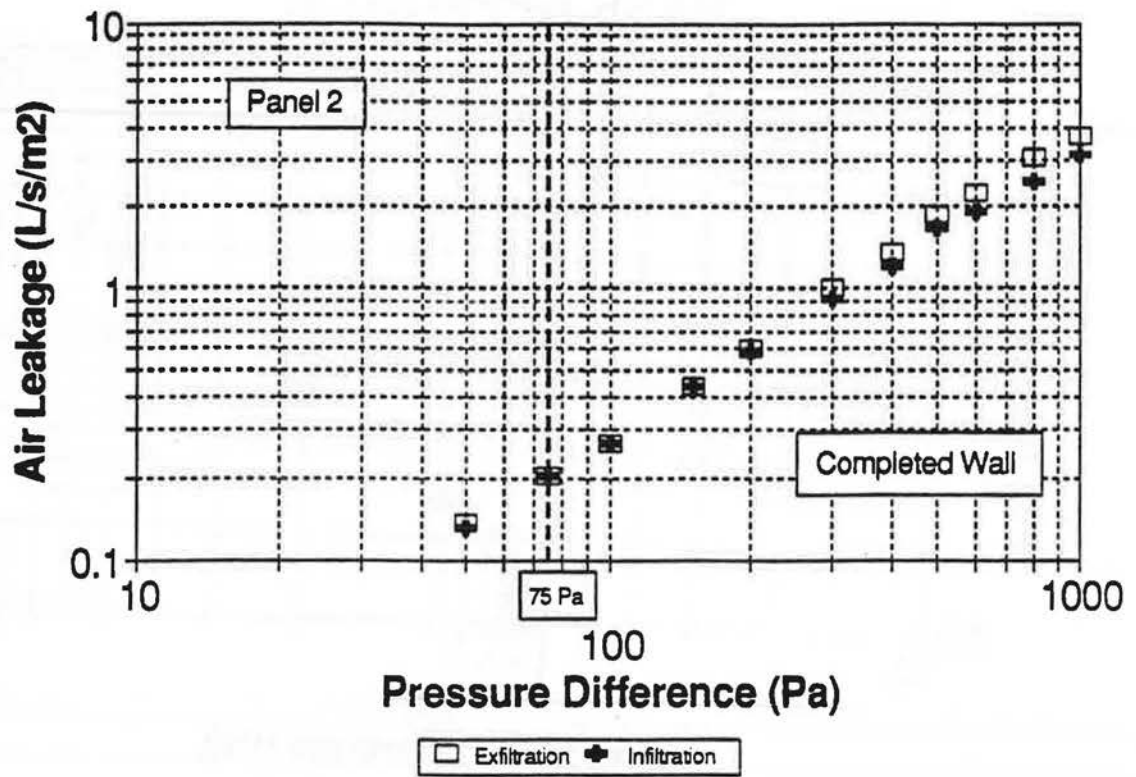

Graph 6

HEADER JOIST TO FLOOR ADA APPROACH

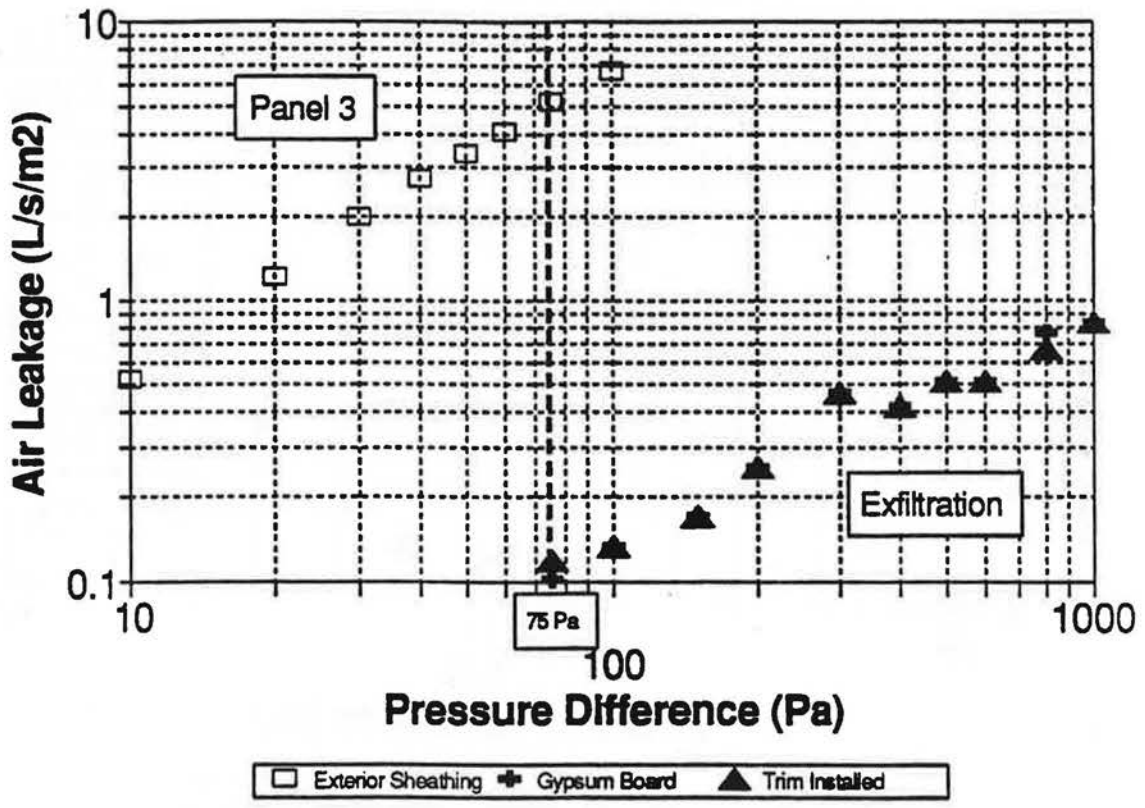

Graph 7

HEADER JOIST DETAIL ADA APPROACH

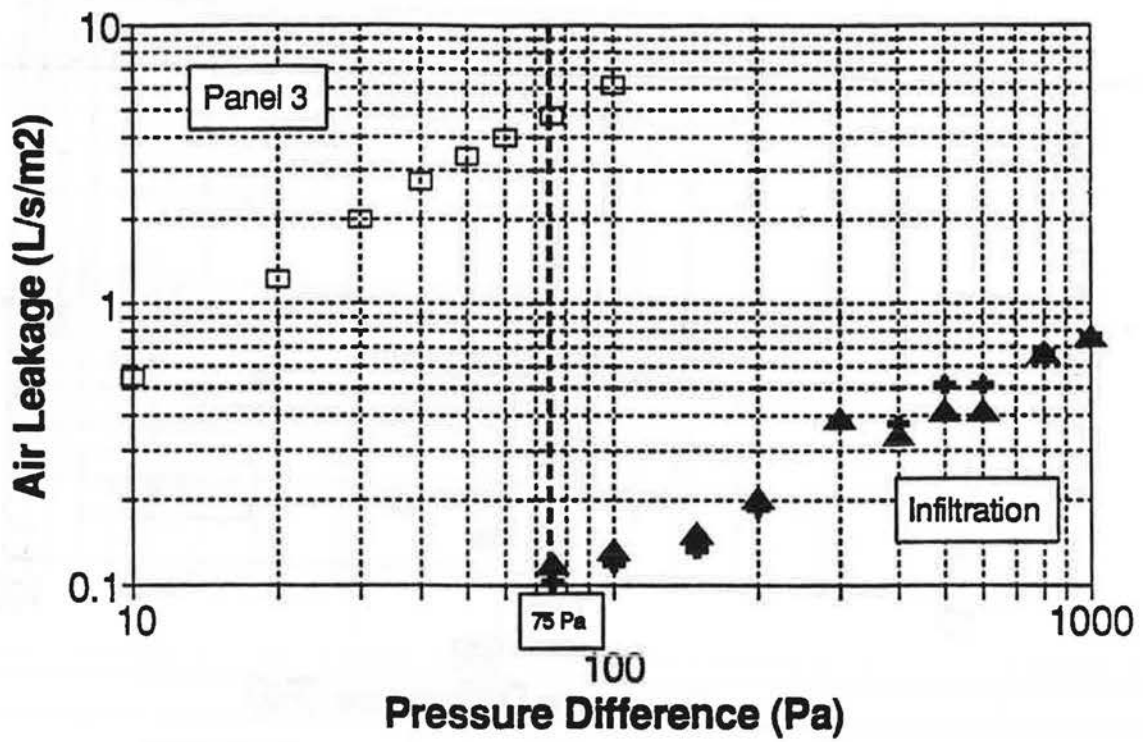

□ Exterior Sheathing + Insulation, Gypsum ▲ Trim installed

Graph 8

HEADER JOIST DETAIL ADA APPROACH

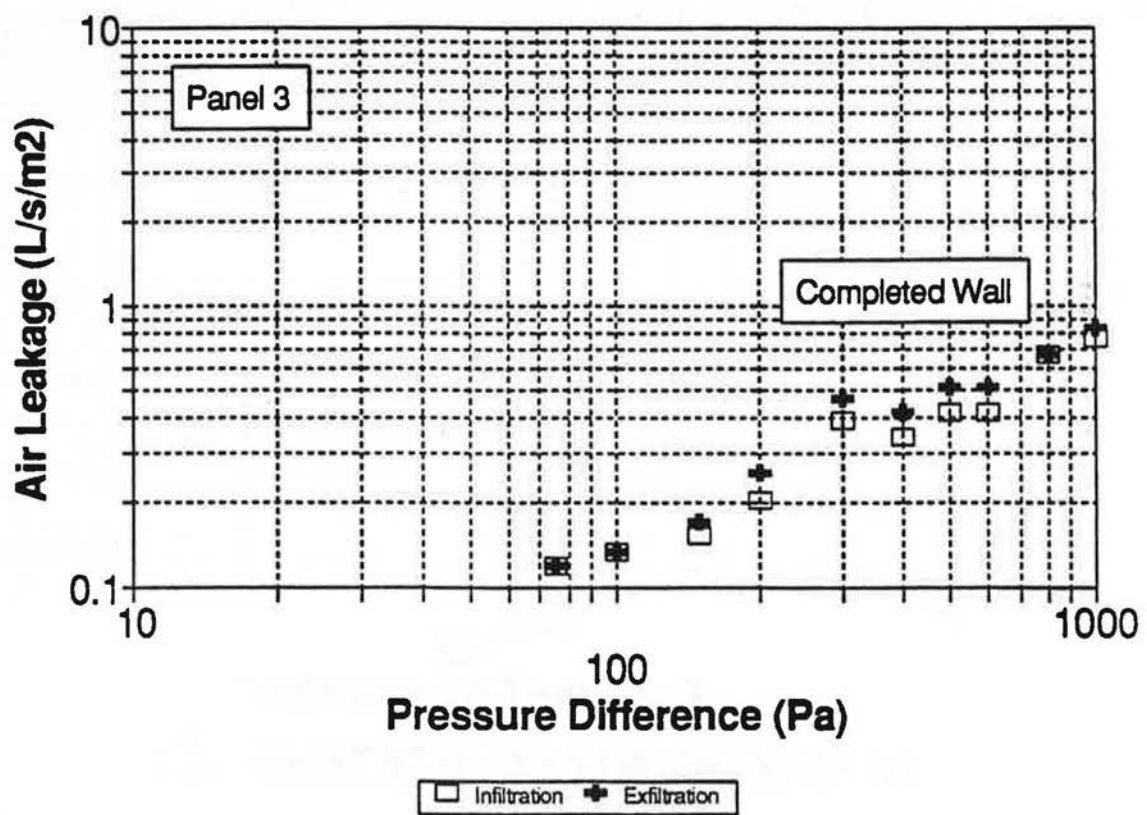

Graph 9

HEADER JOIST DETAIL TRADITIONAL APPROACH

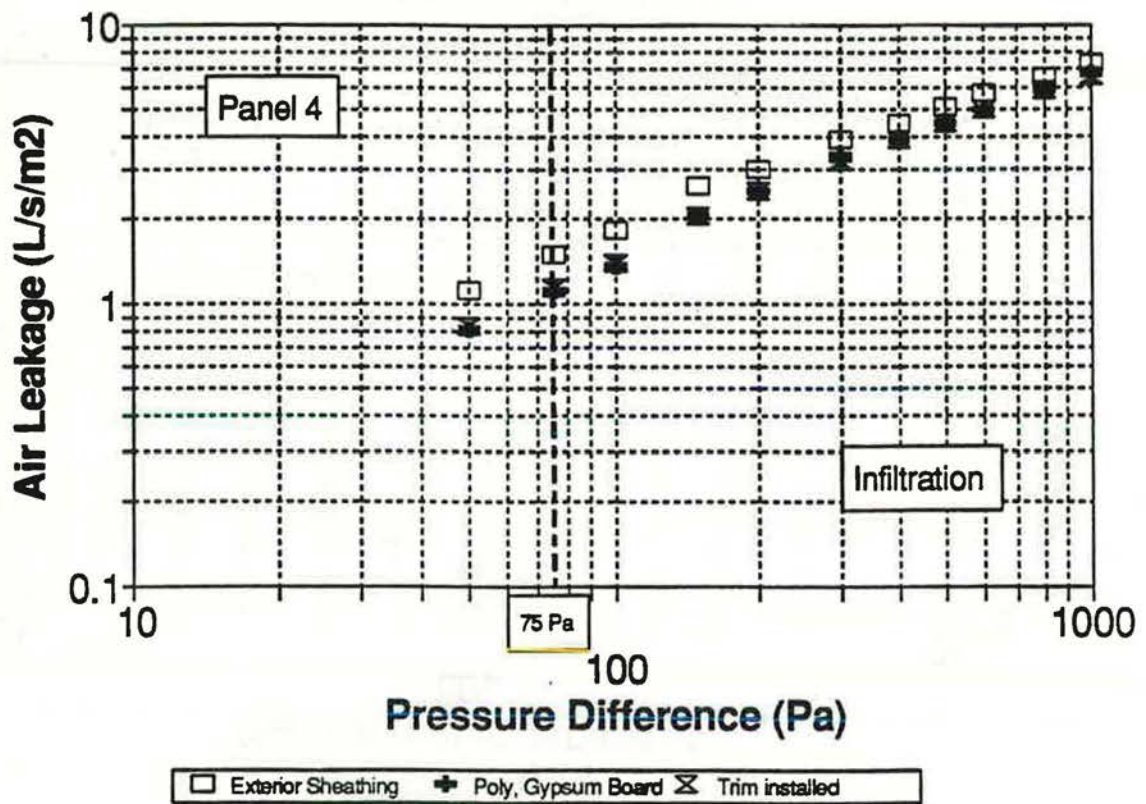

Graph 10

HEADER JOIST DETAIL TRADITIONAL APPROACH

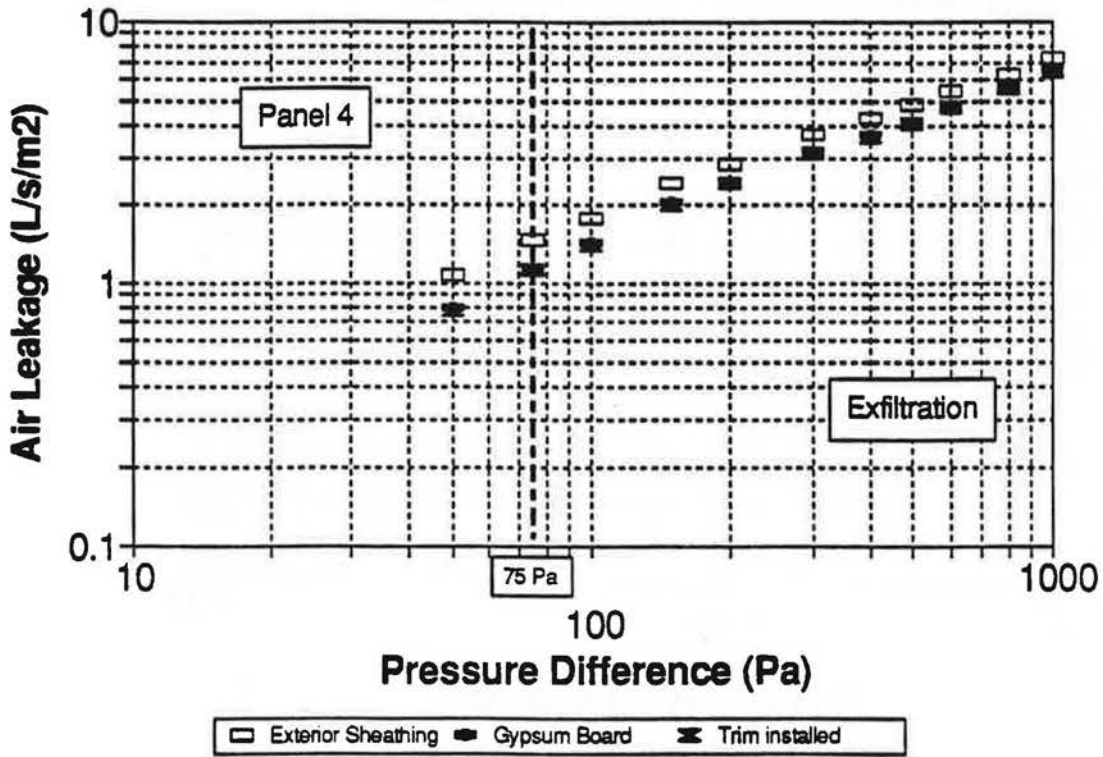

Graph 11

HEADER JOIST DETAIL TRADITIONAL APPROACH

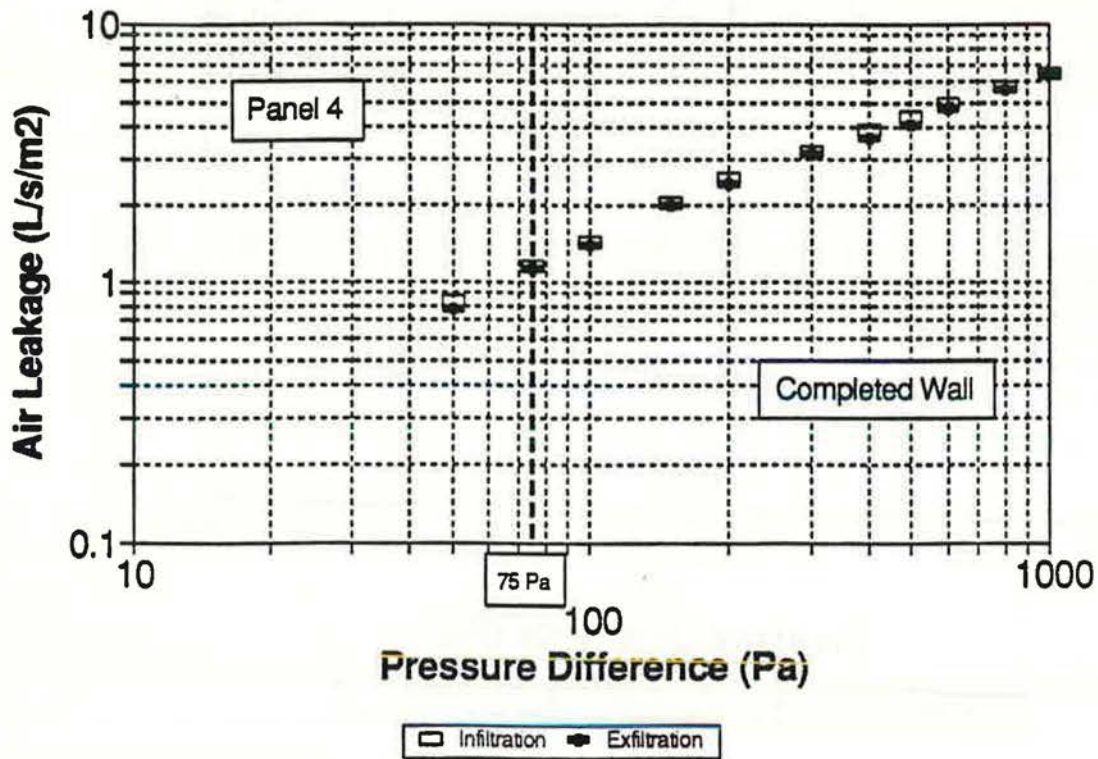

Graph 12

ELECTRICAL OUTLETS POLY APPROACH

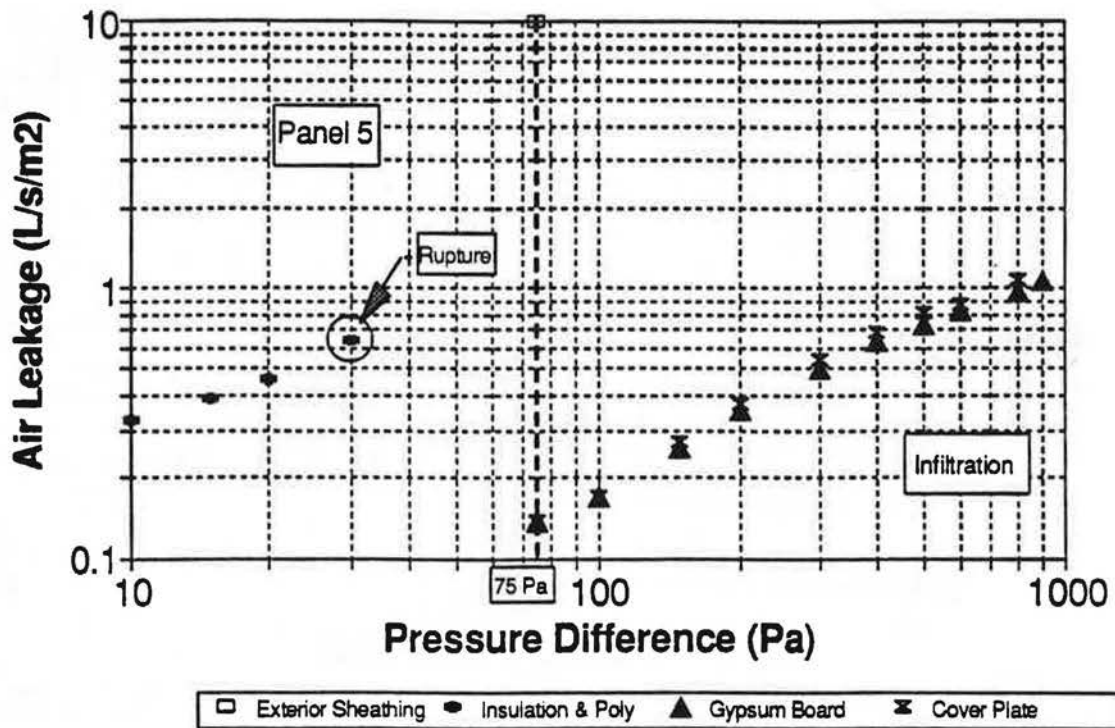

Graph 13

ELECTRICAL OUTLETS POLY APPROACH

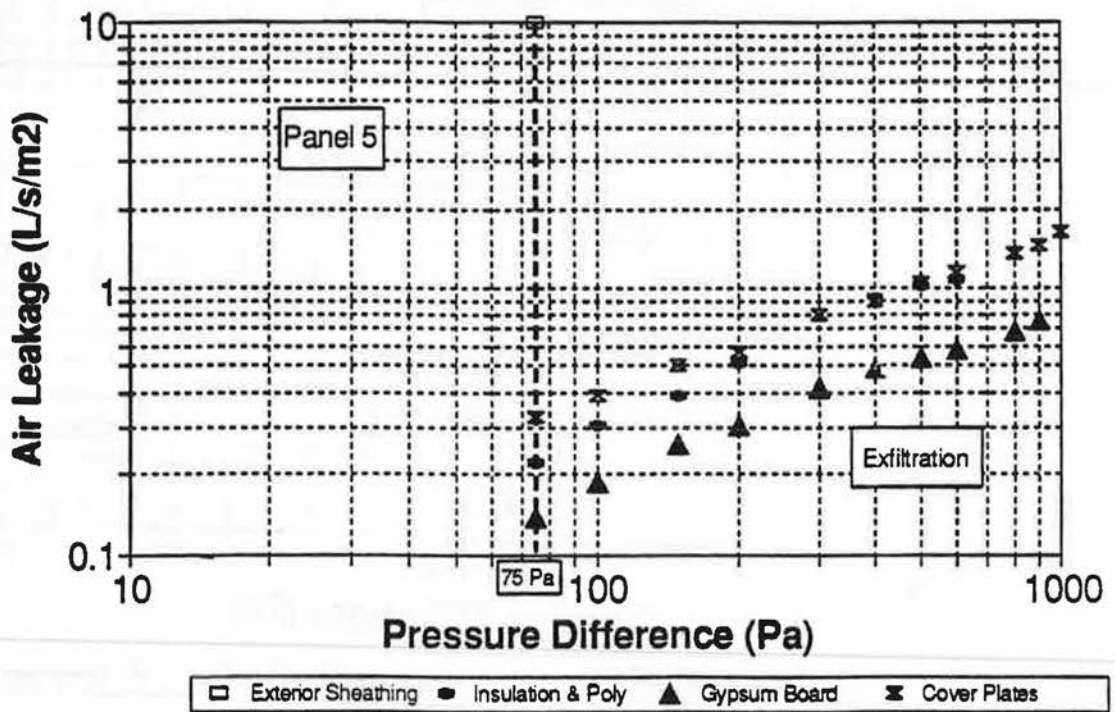

Graph14

ELECTRICAL OUTLETS POLY APPROACH

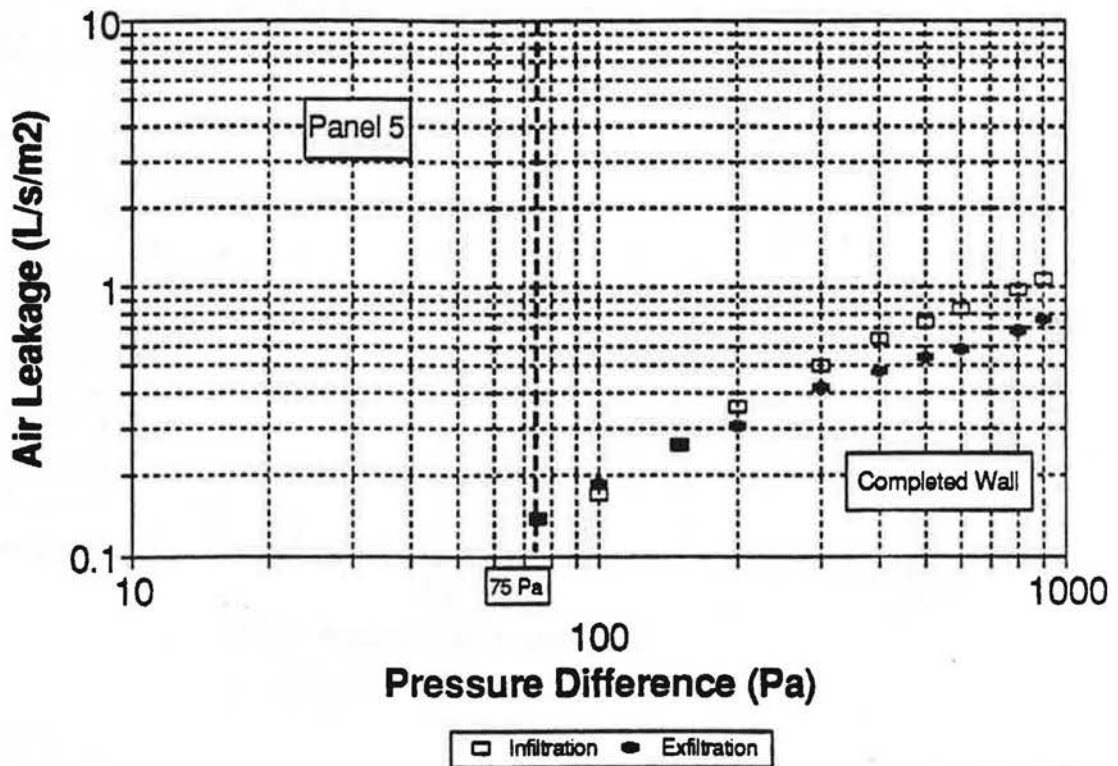

Graph 15

ELECTRICAL OUTLETS EASE APPROACH

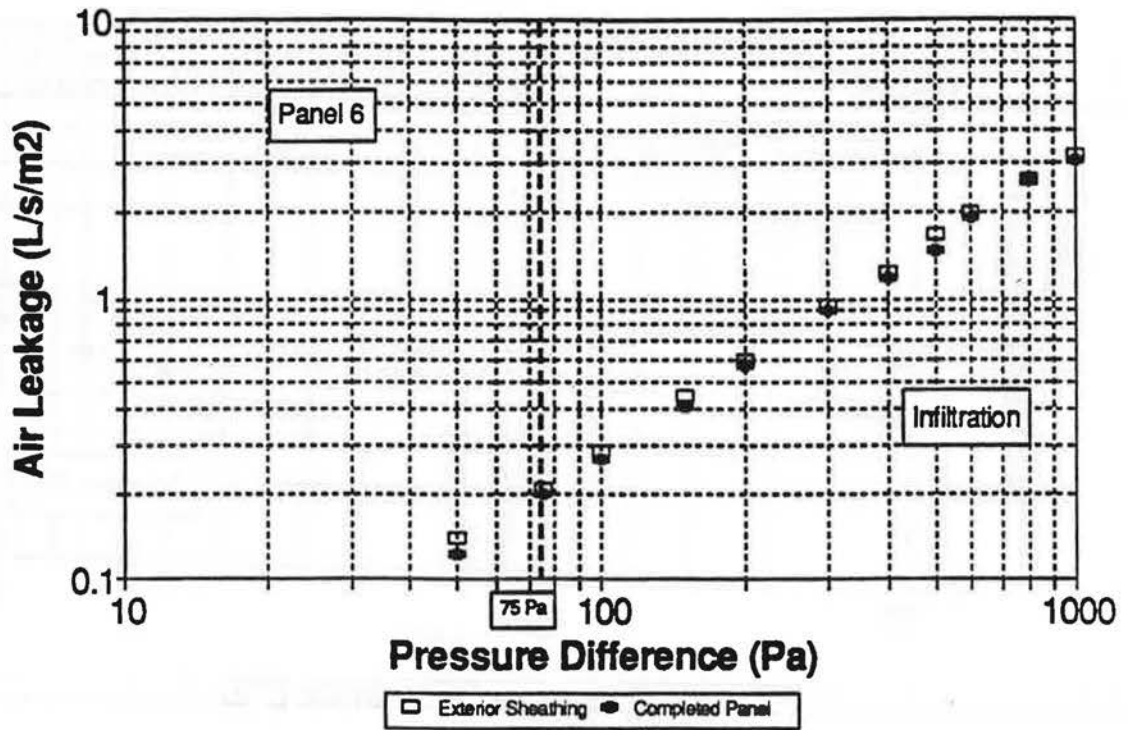

Graph 16

ELECTRICAL OUTLETS EASE APPROACH

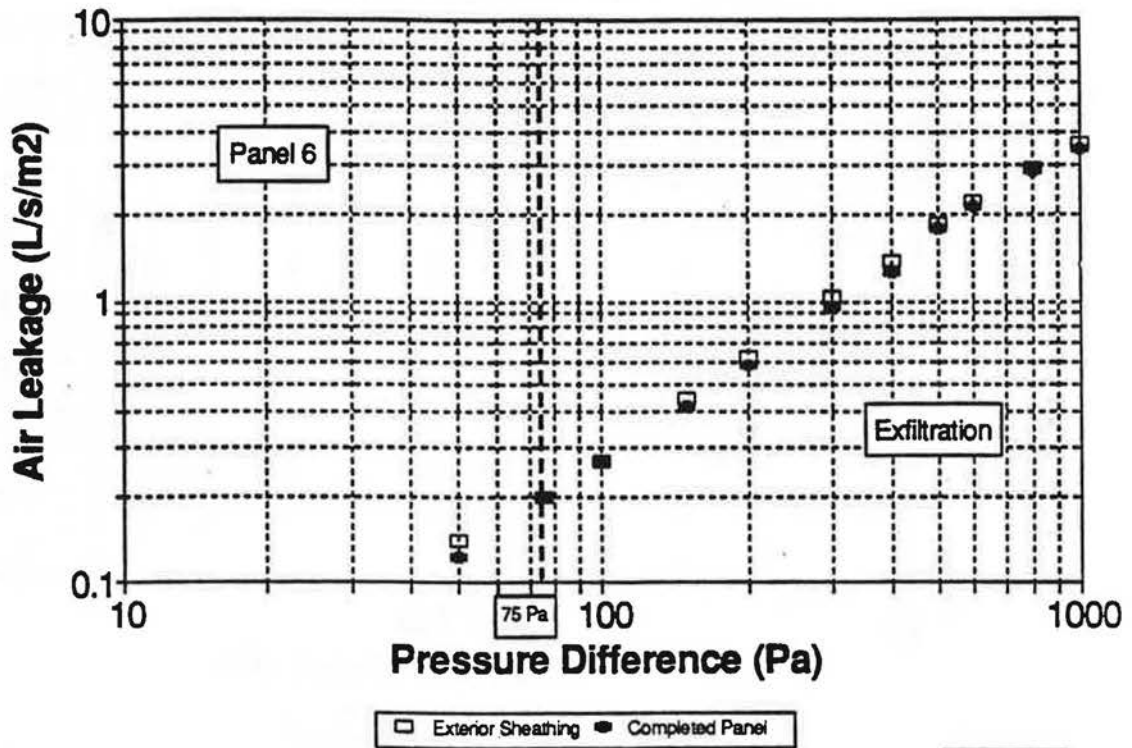

Graph 17

ELECTRICAL OUTLETS EASE APPROACH

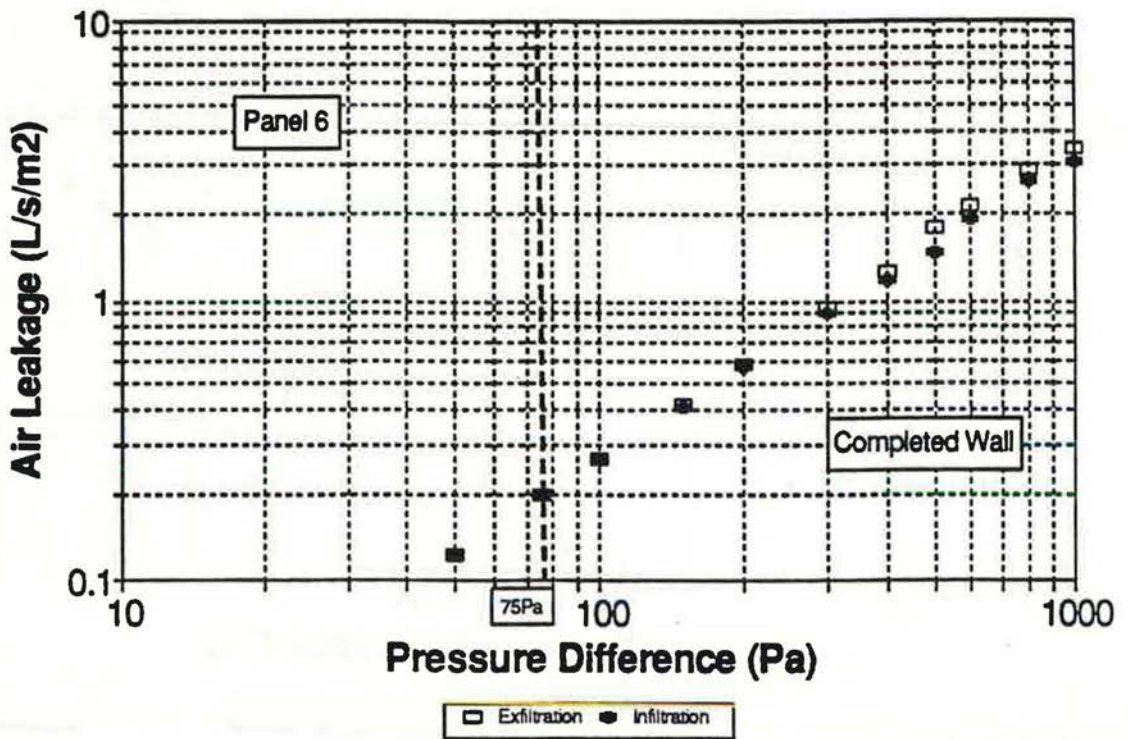

Graph 18

ELECTRICAL OUTLETS ADA APPROACH

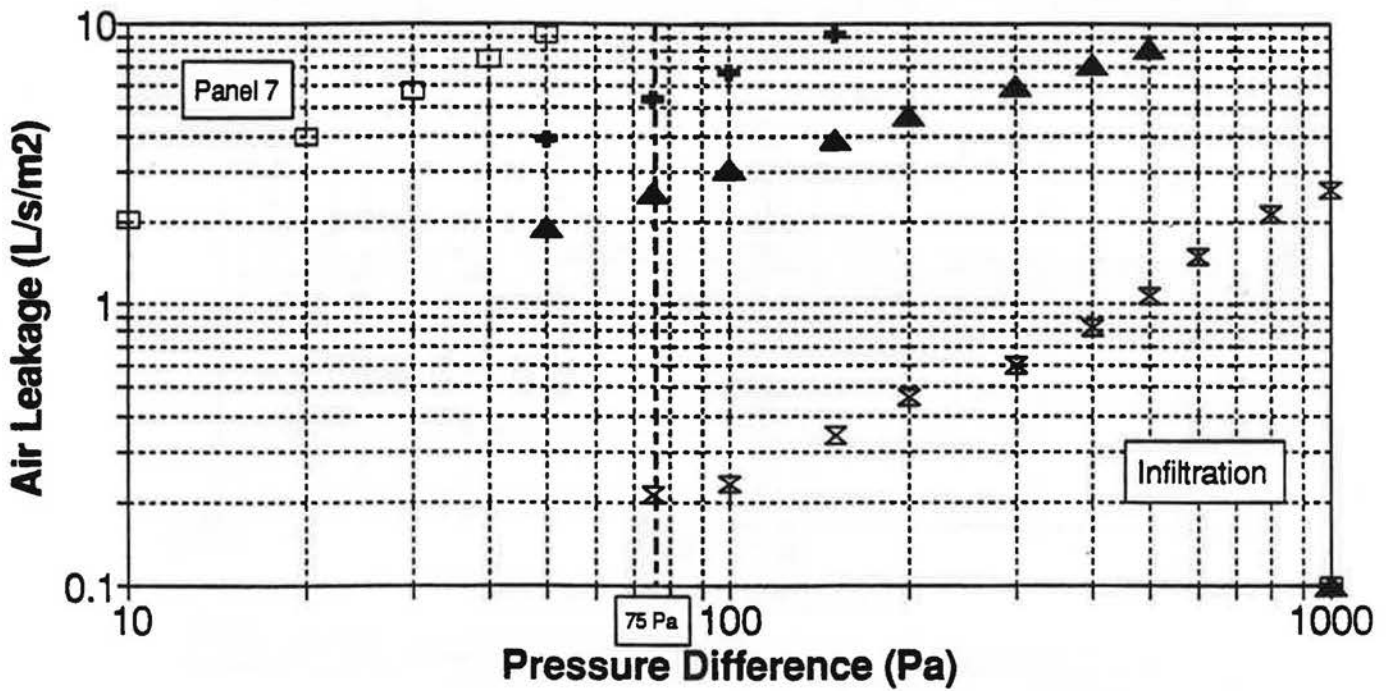

□ Exterior Sheathing
+ Gypsum Board
▲ Foam Gasket & cover
⊗ Poly over outlet

* cover outlets with poly

Graph 19

ELECTRICAL OUTLETS ADA APPROACH

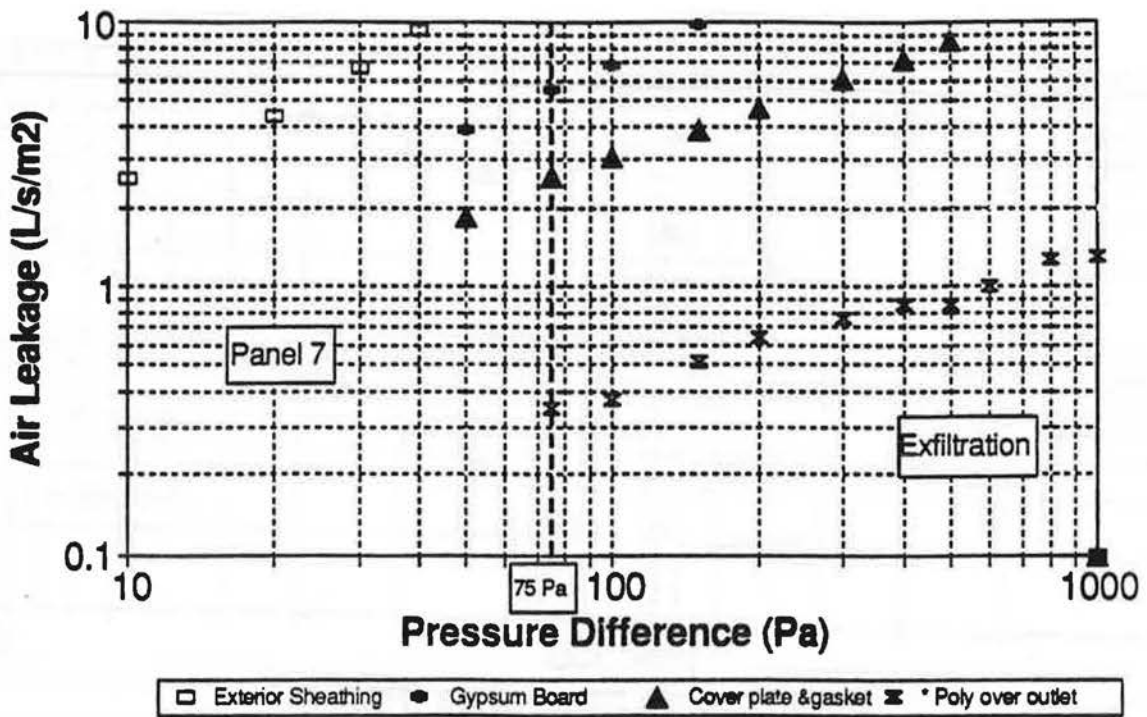

Graph 20

ELECTRICAL OUTLETS ADA APPROACH

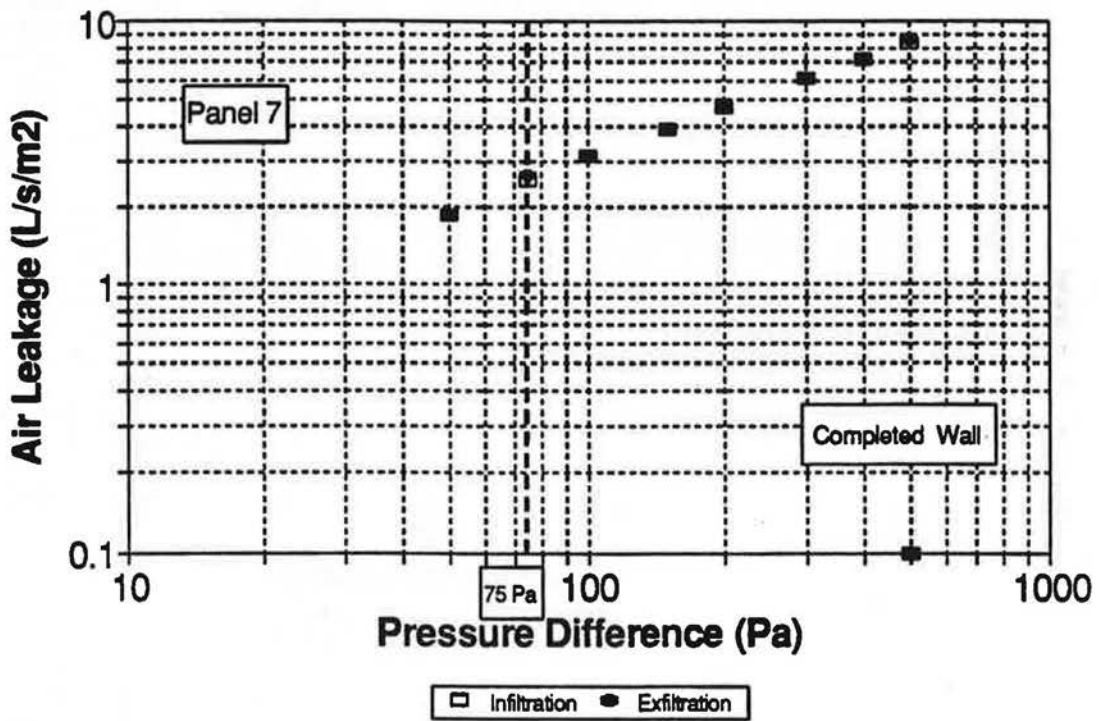

Graph 21

ELECTRICAL OUTLETS TRADITIONAL APPROACH

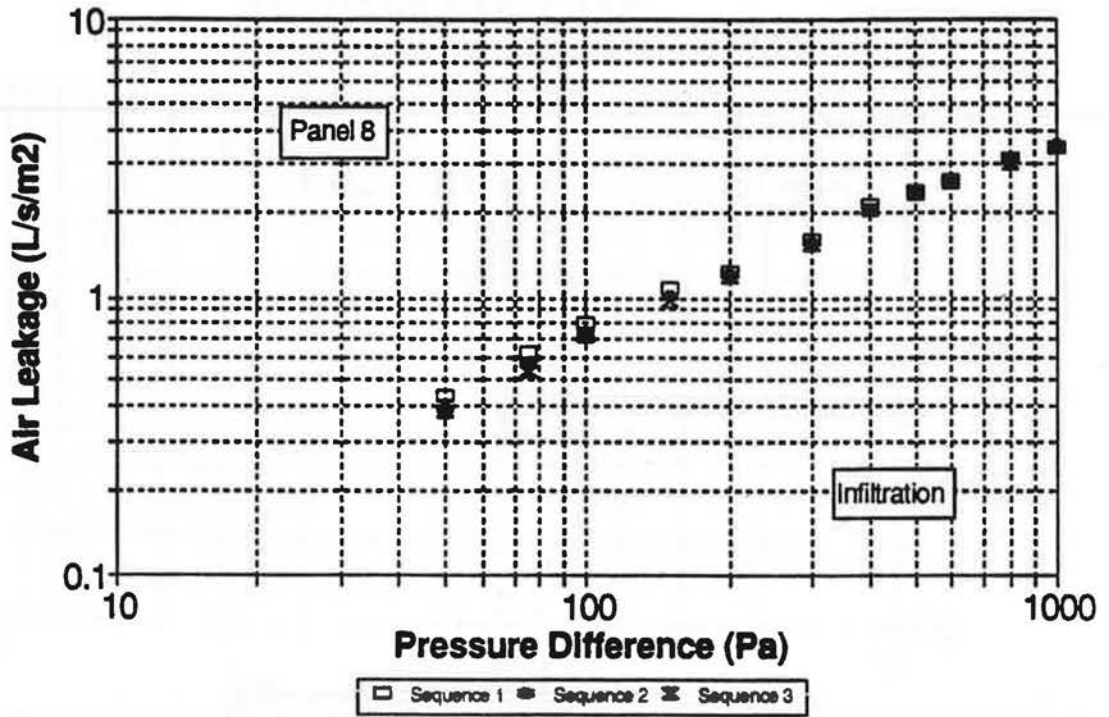

Graph 22

ELECTRICAL OUTLETS TRADITIONAL APPROACH

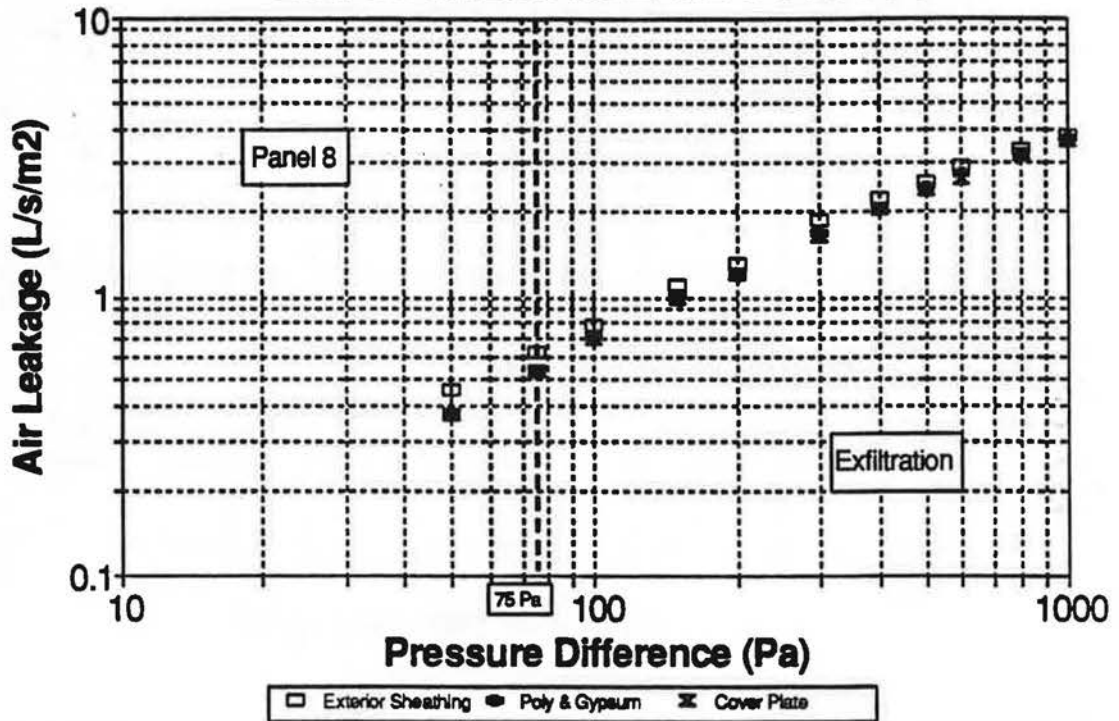

Graph 23

ELECTRICAL OUTLETS TRADITIONAL APPROACH

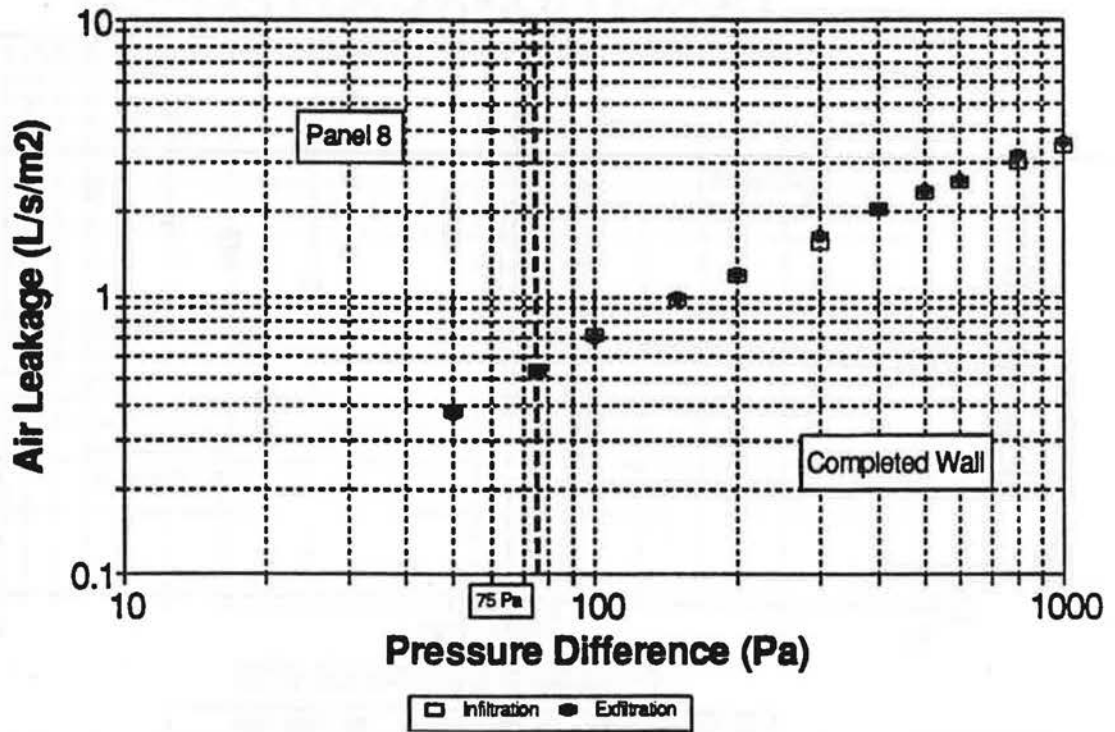

Graph 24

WINDOWS POLY APPROACH

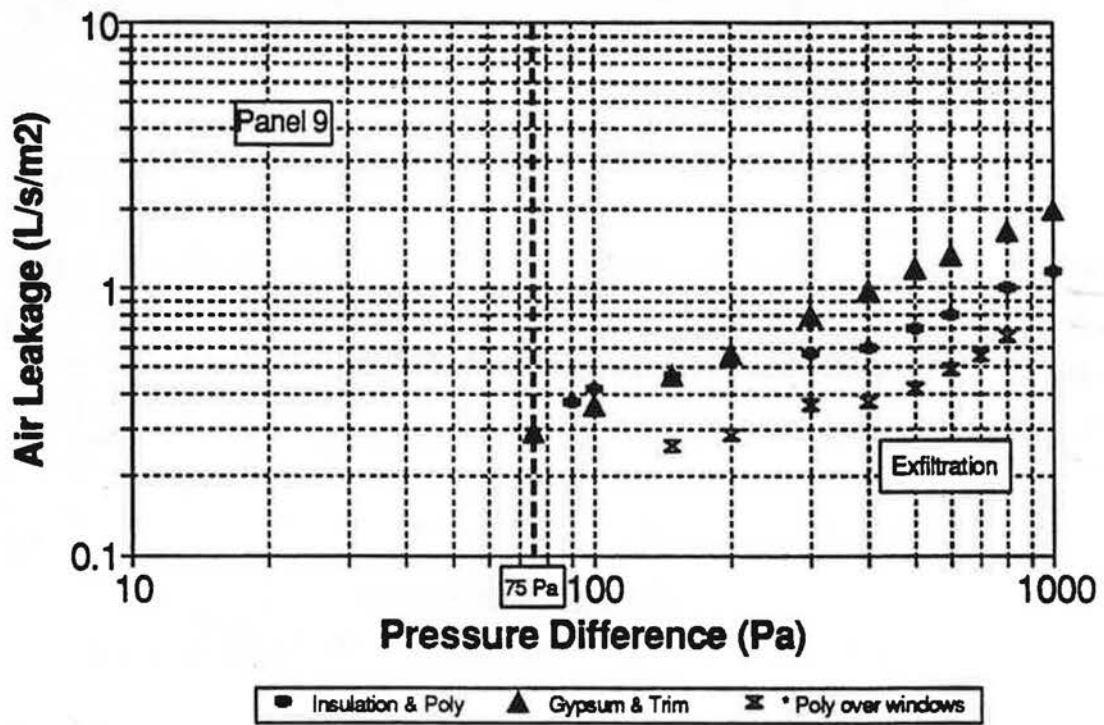

Graph 25

WINDOWS POLY APPROACH

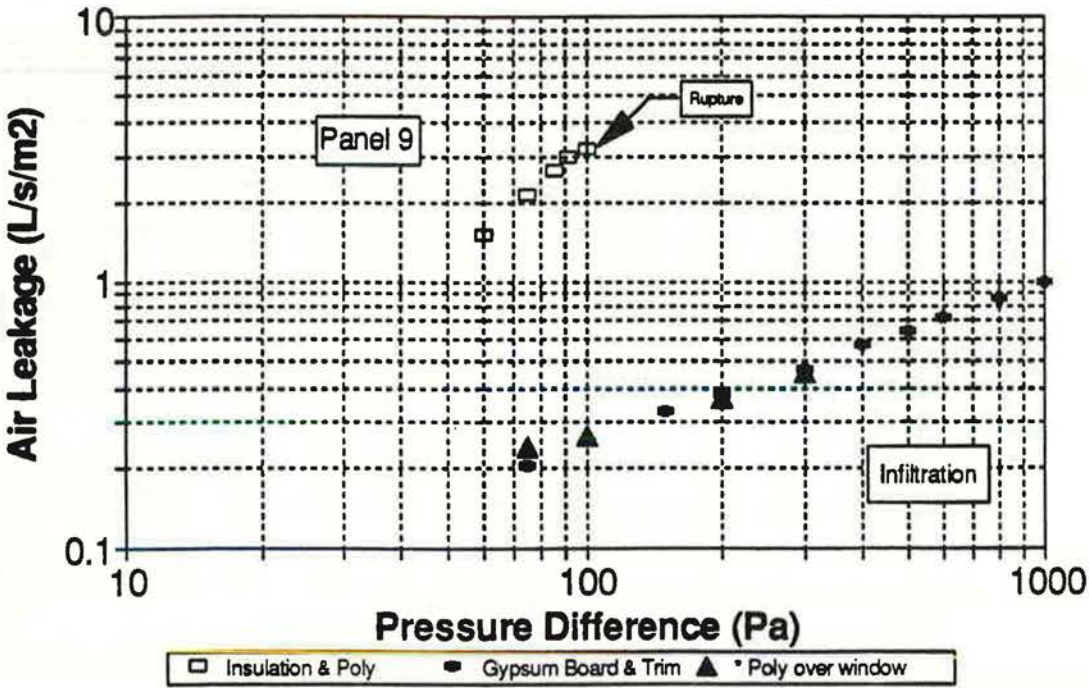

GRAPH 26

WINDOWS POLY APPROACH

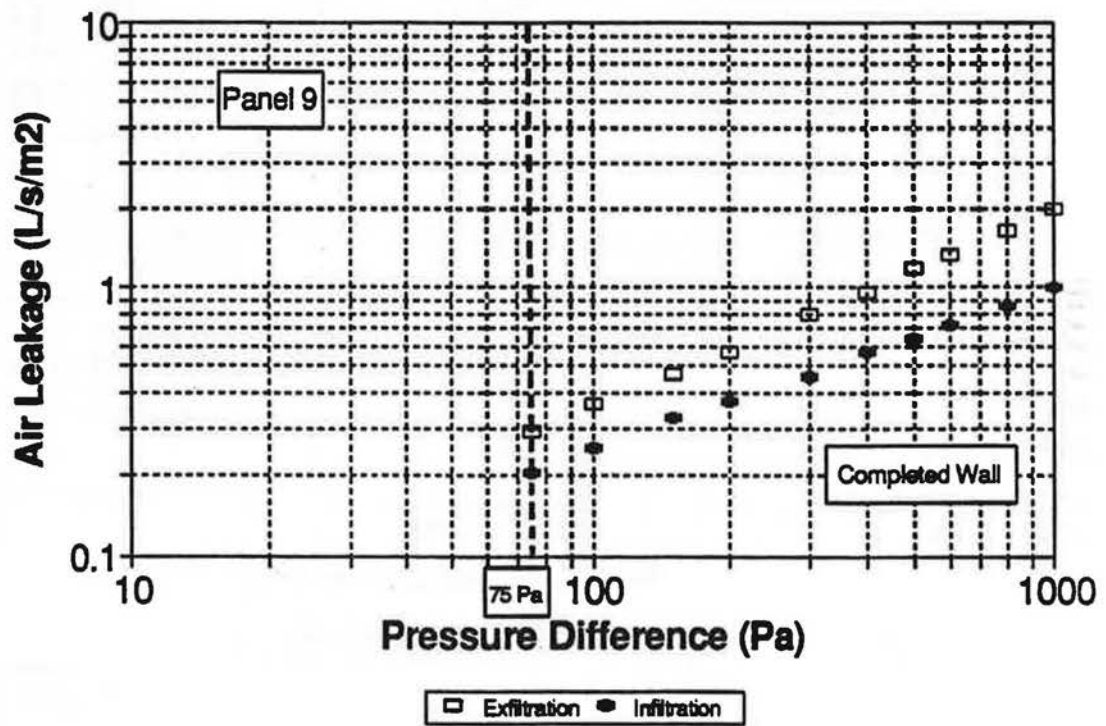

Graph 27

WINDOW DETAIL EASE APPROACH

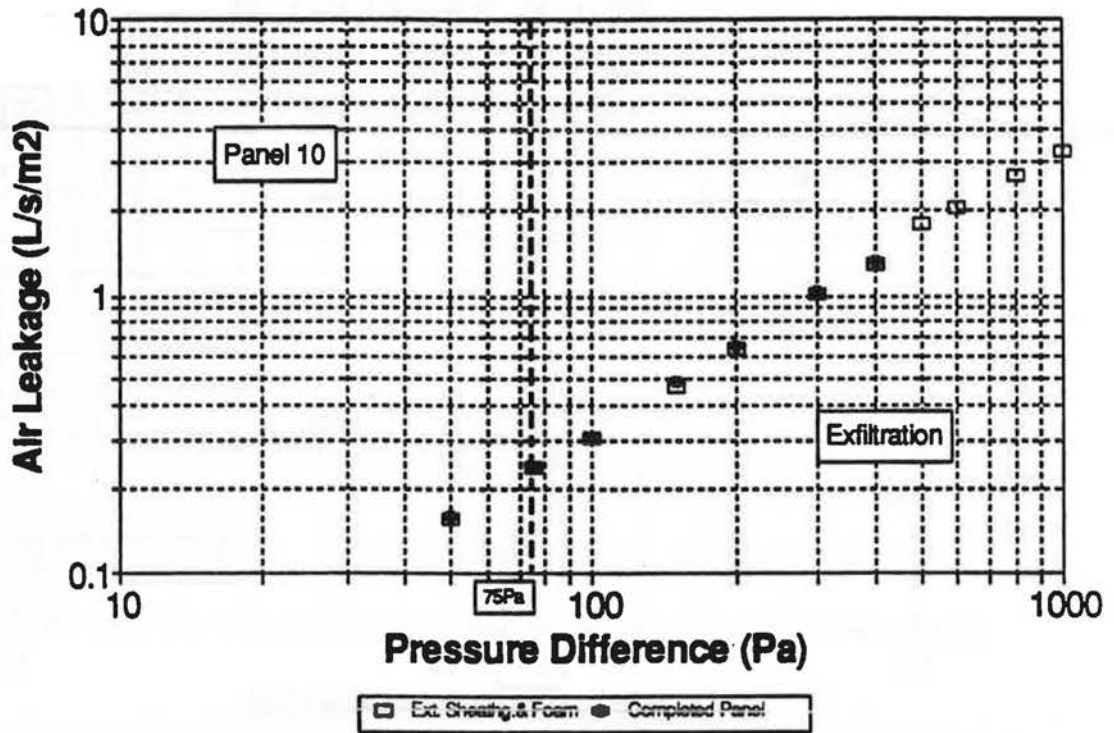

Graph 28

WINDOW DETAIL EASE APPROACH

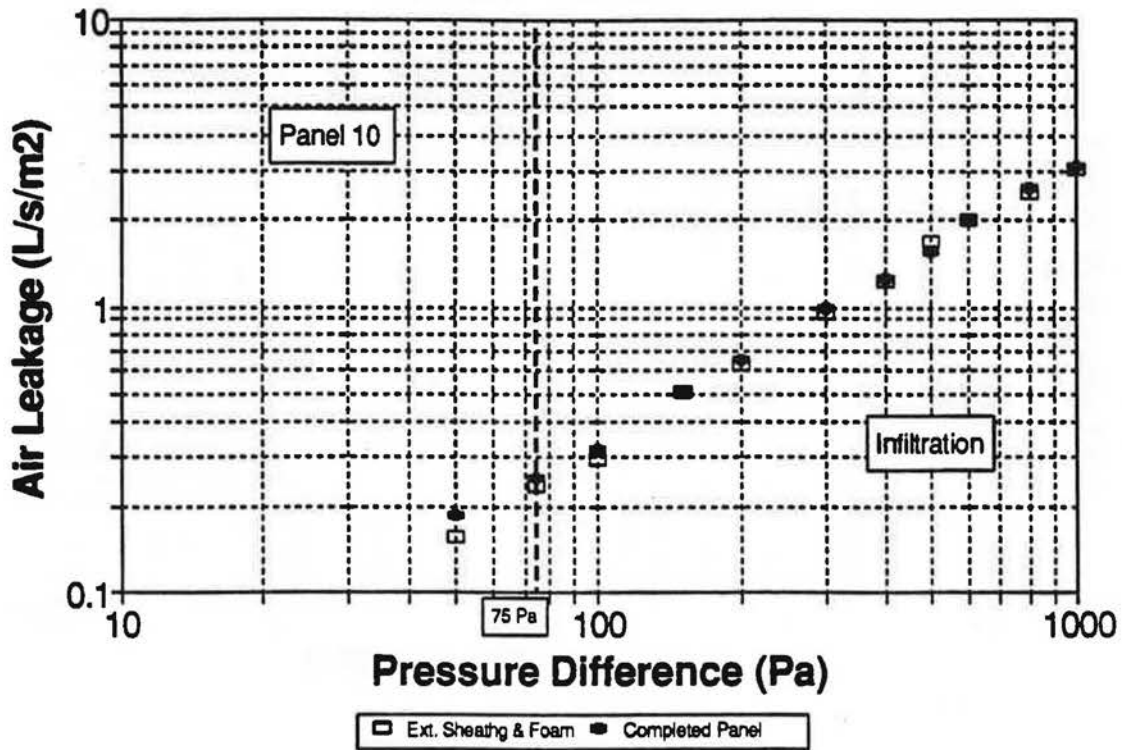

Graph 29

WINDOW DETAIL EASE APPROACH

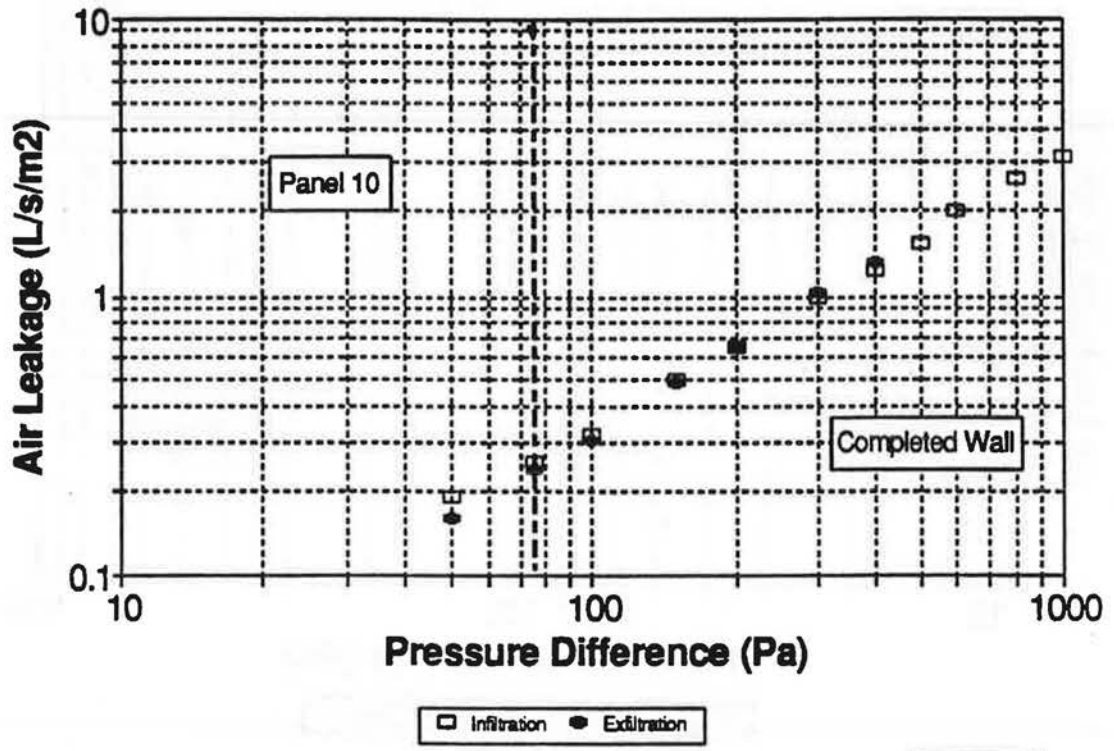

Graph 30

WINDOWS ADA APPROACH

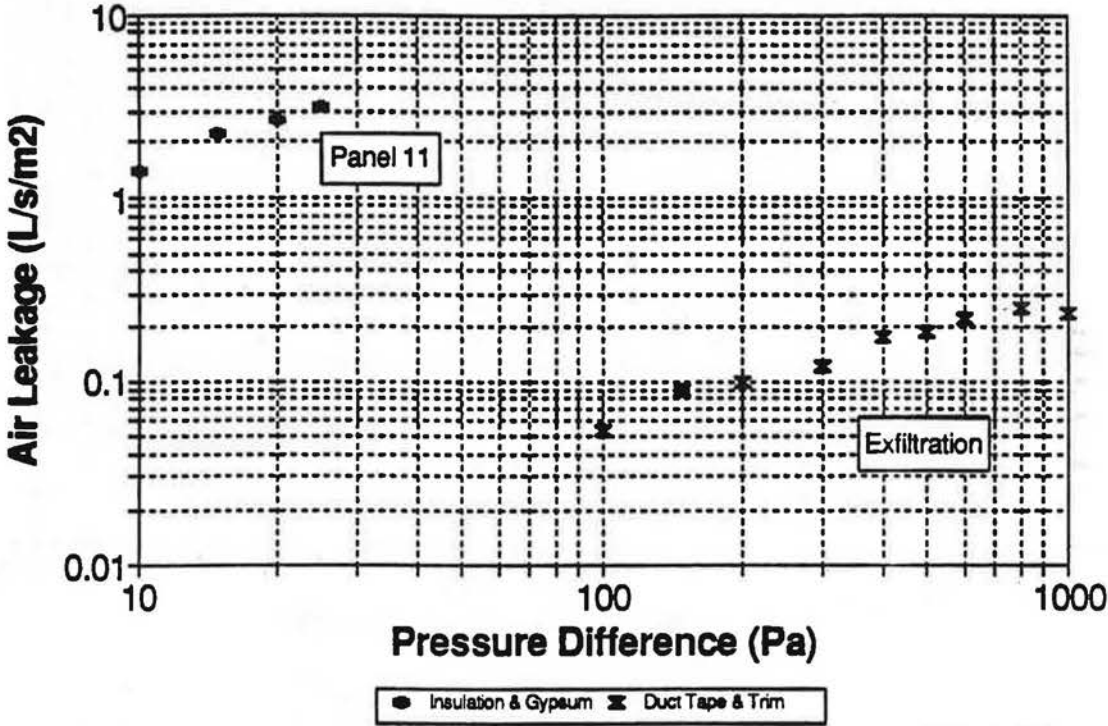

Graph 31

WINDOWS ADA APPROACH

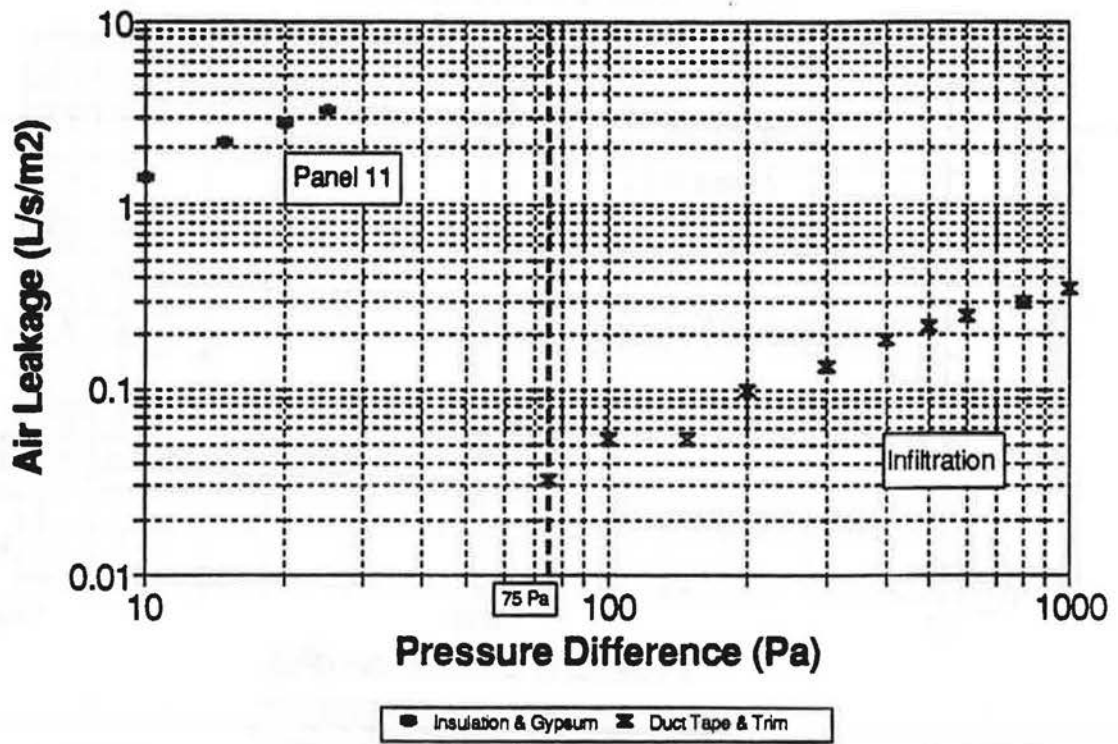

Graph 32

WINDOWS ADA APPROACH

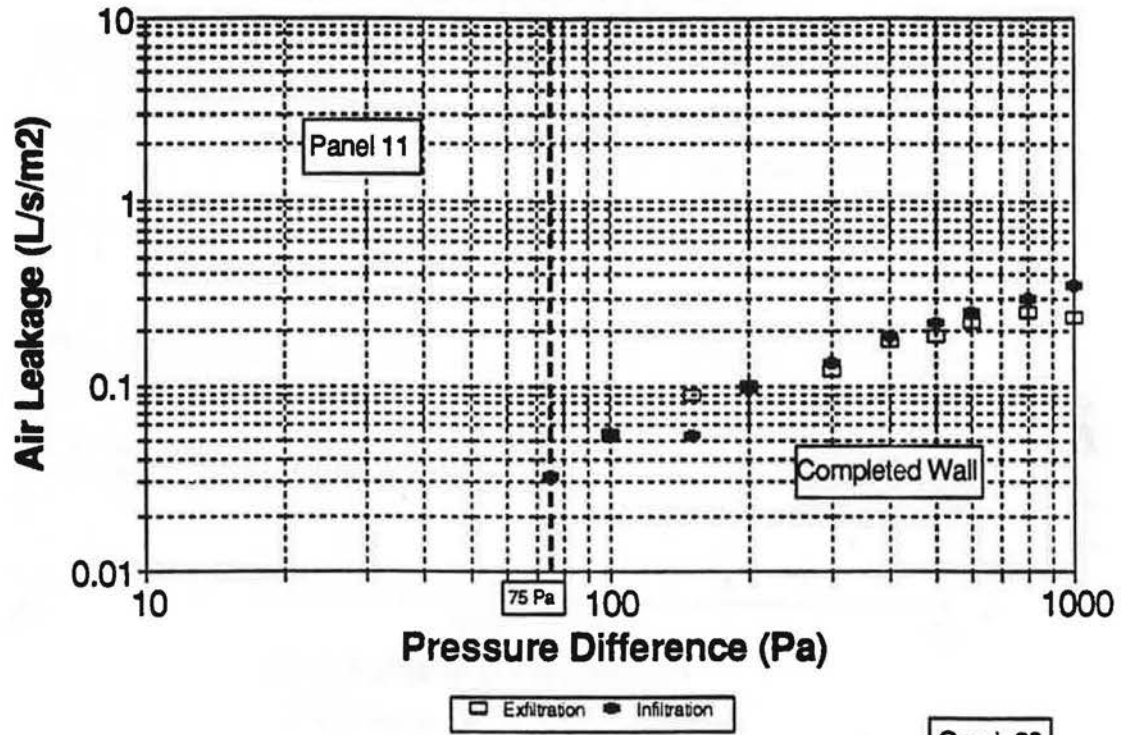

Graph 33

WINDOW DETAIL TRADITIONAL APPROACH

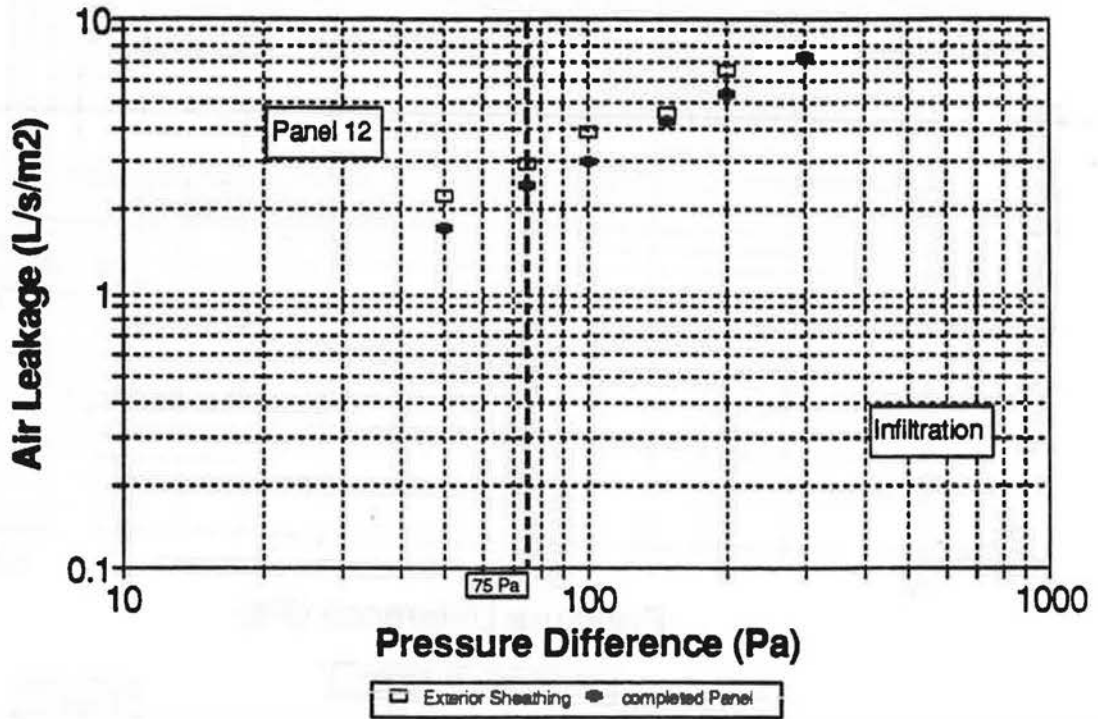

Graph 34

WINDOW DETAIL TRADITIONAL APPROACH

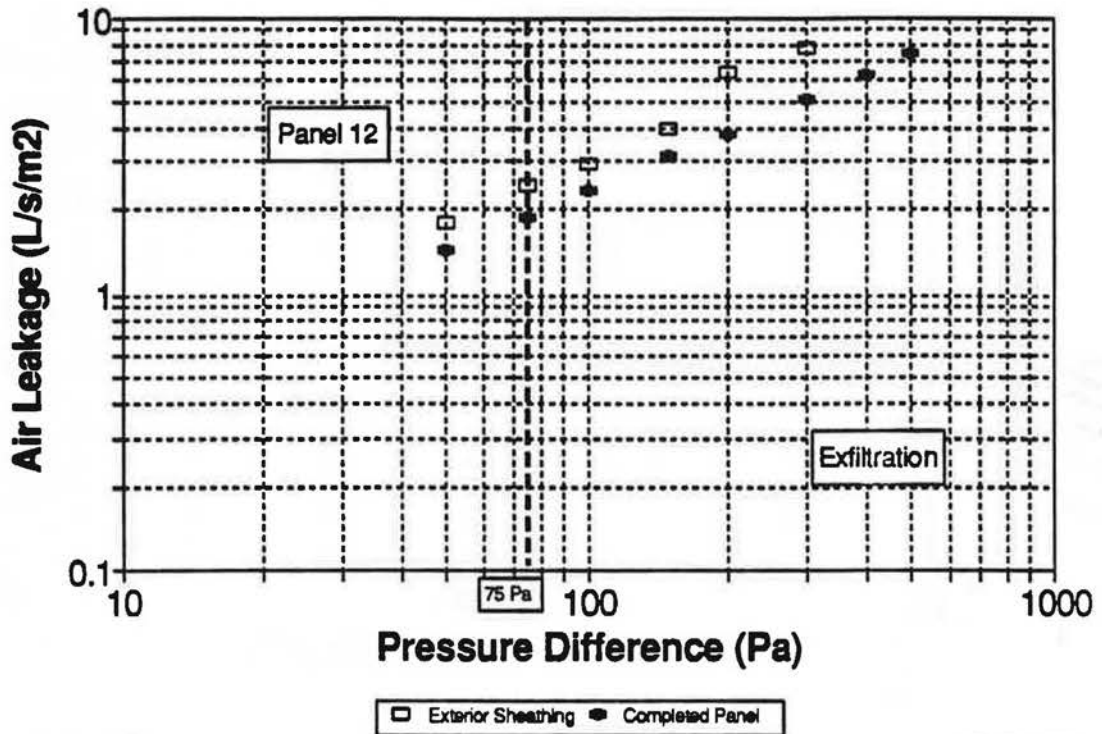

Graph 35

WINDOW DETAIL TRADITIONAL APPROACH

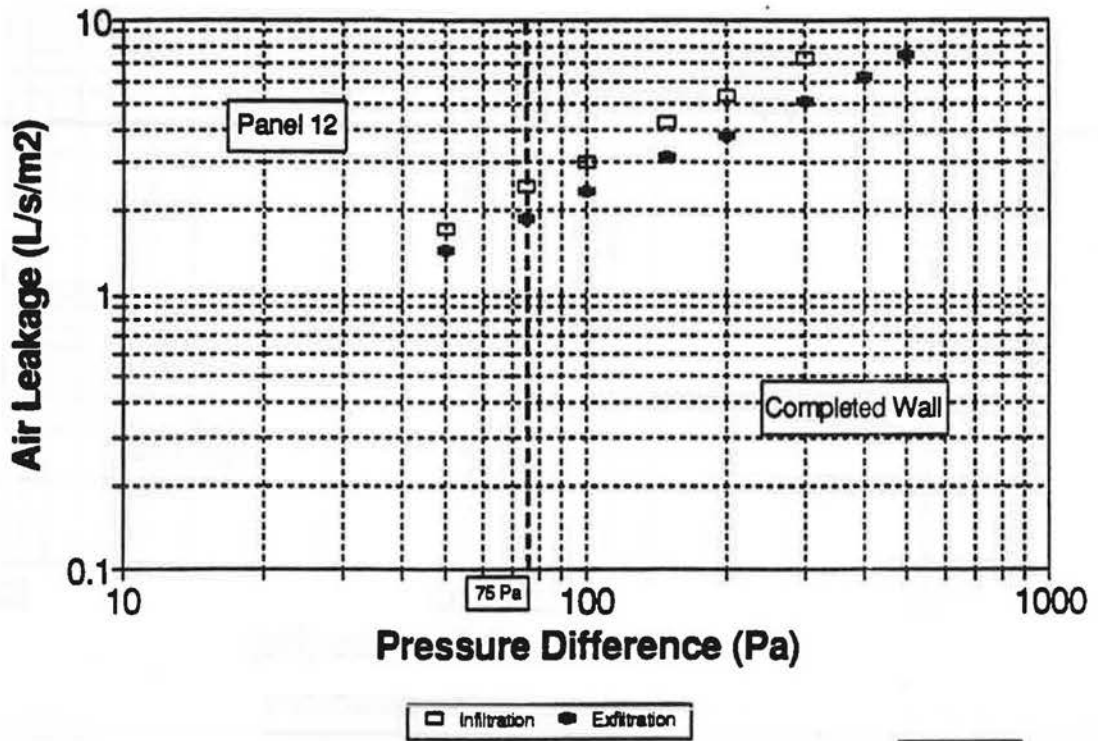

Graph 36