

#3744

**KITCHENER  
TOWNHOUSE  
STUDY**

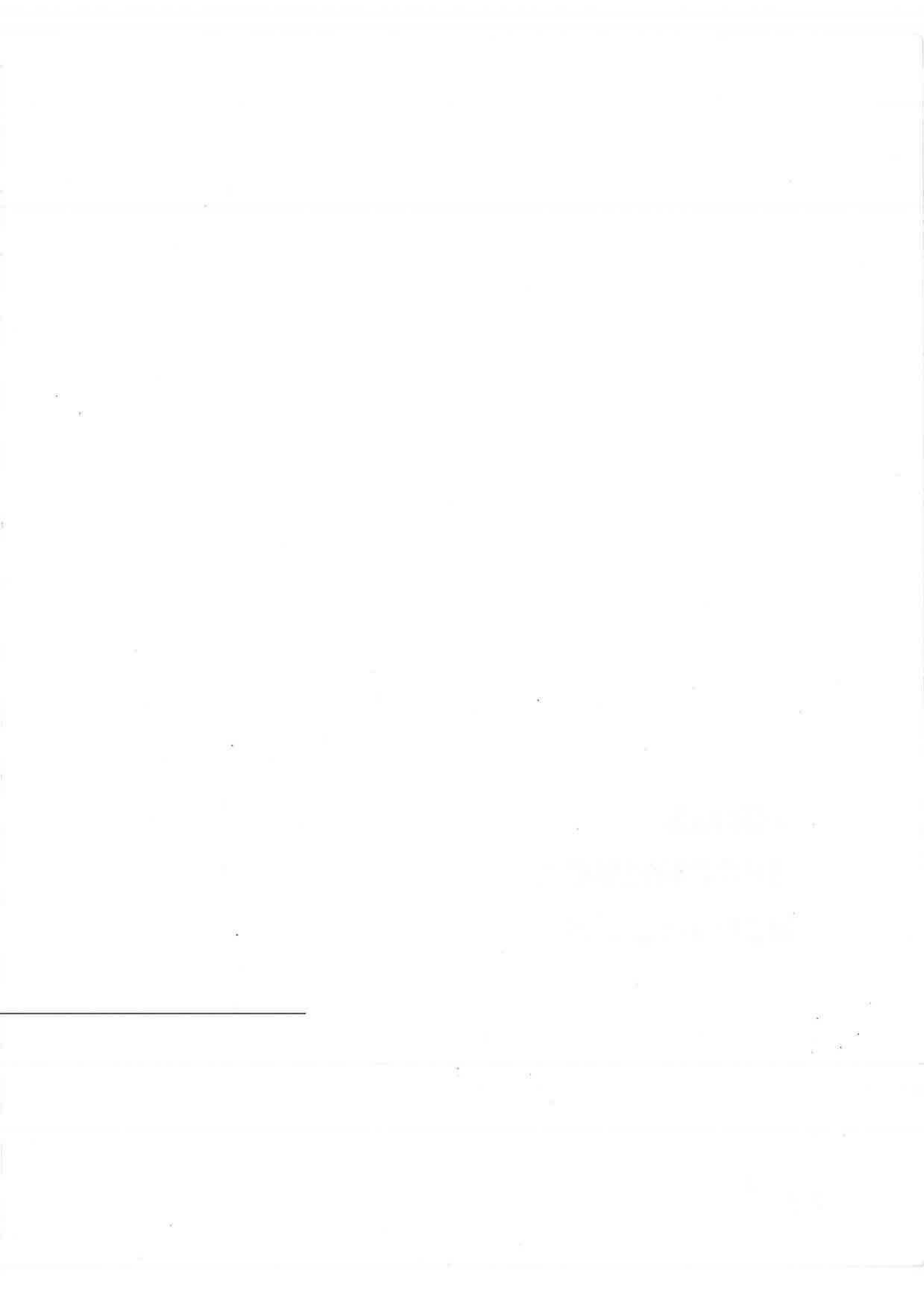

Project: KI23918.A0

CMHC KITCHENER TOWNHOUSE STUDY OF  
SOIL GAS VENTILATION AS A  
REMEDIAL MEASURE FOR METHANE  
ENTRY INTO BASEMENTS

Prepared for:

The Research Division  
Canada Mortgage and Housing Corporation

by:

CH2M HILL ENGINEERING LTD.  
Waterloo, Ontario

June 1989  
(Second Issue)



## DISCLAIMER

This study was conducted by CANVIRO Consultants for Canada Mortgage and Housing Corporation under Part V of the National Housing Act. The analysis, interpretations, and recommendations are those of the consultants and do not necessarily reflect the views of Canada Mortgage and Housing Corporation or those divisions of the Corporation that assisted in the study and its publication.

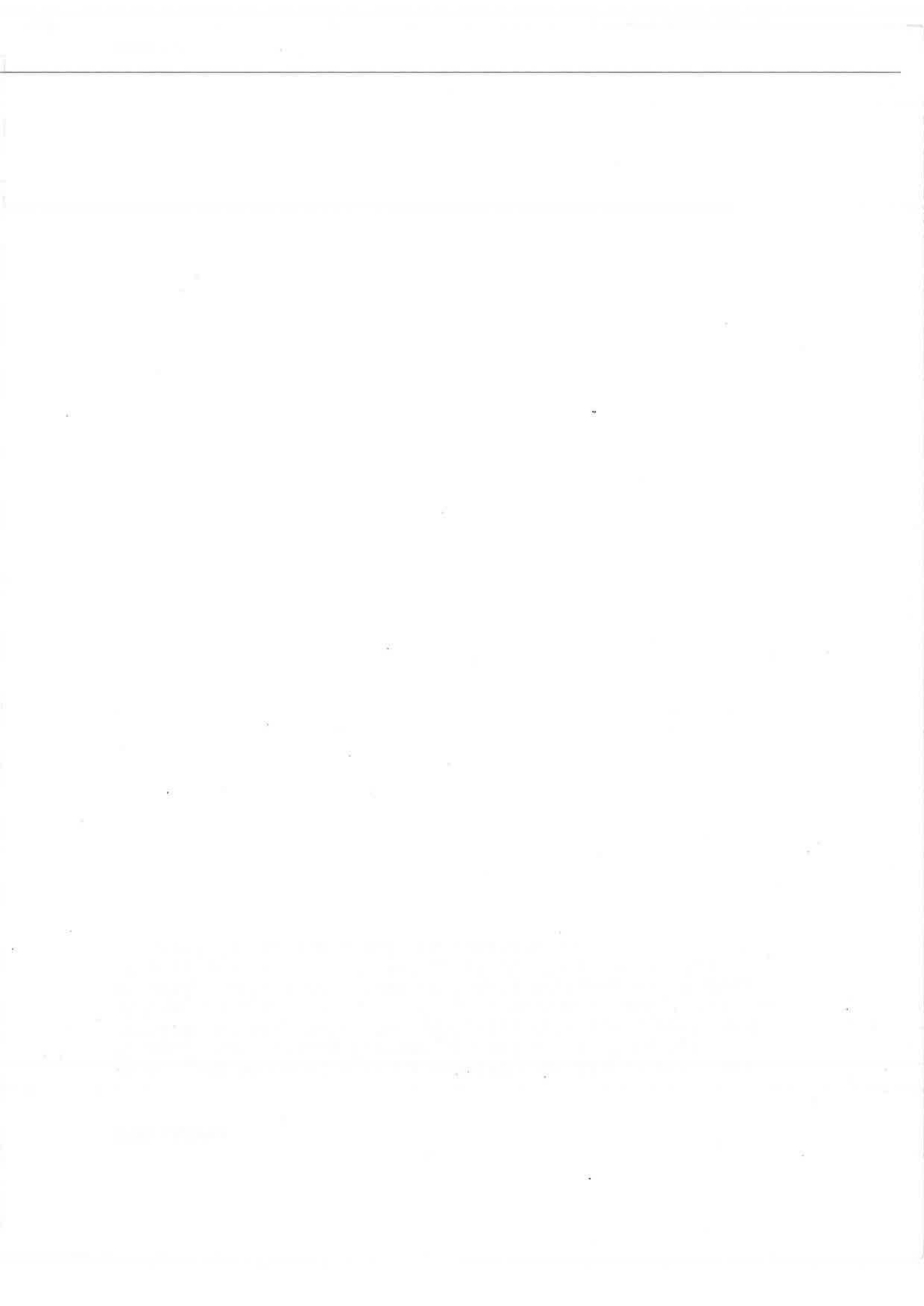

## ABSTRACT

Methane entry into basements is a widespread problem for housing structures situated close to either natural or man-made sources of methane. This study was aimed at determining a solution to a methane problem at a group of townhouses situated in Kitchener, Ontario. The source of methane at this site originates from nearby buried refuse. Various remedial solutions including passive venting systems installed at foundation levels and perimeter gas collection systems have proven ineffective. More expensive solutions, such as the removal of onsite refuse, have also been suggested.

In view of mounting costs as well as the expensive recommended solution, other less expensive alternatives required attention. As an alternative, a technology known as active soil gas ventilation was implemented at this site. Although this technology has not extensively been used as a mitigative measure for methane migration, active soil gas ventilation has been very successful in mitigating radon entry into houses by reducing concentrations by as much as 99 percent. Soil ventilation essentially modifies the local pressure distribution around basements such that air flow is from the basements out toward the soil zone. Furthermore, soil ventilation may be implemented at relatively low costs since most building structures are well suited for this remedial action.

Two different soil ventilation systems were used in this study. On one row of townhouses, a series of interior soil gas extraction wells were implemented while on another townhouse block, a buried ventilation system was used. Due to problems of soils with poor permeabilities, the perimeter ventilation system registered only marginal improvements. The series of interior soil gas extraction wells however could strategically be placed, thereby effectively reducing methane concentrations by as much as 99 percent.

Based on the results of this research, homes which are currently affected by methane migration, and have similar soil characteristics, can be remediated by soil ventilation processes.





## CONTENTS

	<u>Page</u>
1.0 INTRODUCTION	1-1
1.1 Study Background	1-1
1.2 Study Scope and Objectives	1-4
2.0 METHODOLOGY	2-1
2.1 Proposed System	2-1
3.0 FIELD TESTING PROGRAM	3-1
3.1 Pre-pumping Phase	3-1
3.2 Active Pumping Phase	3-4
3.3 Post-Pumping Phase	3-12
3.4 Alternatives Assessment Phase	3-13
4.0 RESULTS	4-1
4.1 Methane	4-1
4.2 Pressure	4-8
4.3 Carbon Monoxide	4-10
4.4 Carbon Dioxide	4-11
4.5 Relative Humidity and Temperature	4-11
4.6 Volatile Organic Compounds	4-11
5.0 DISCUSSION OF RESULTS	5-1
5.1 Overview of Baseline Methane Concentrations	5-1
5.2 Effects of Active Soil Ventilation (Depressurization)	5-3
5.3 Effects of Active Soil Ventilation (Pressurization)	5-8
5.4 Volatile Organic Compounds	5-9
5.5 System Analysis	5-12
6.0 CONCLUSIONS	6-1
7.0 REFERENCES	7-1
 Appendix A	 Summary of Field Results
Appendix B	Supplementary Documentation



## TABLES

	<u>Page</u>
1 List of Equipment	3-3
2 Methane Concentration Ranges in Blocks A and B	4-3
3 Methane Concentration Ranges in Blocks B and C	4-3
4 Summary of VOC Sampling Program	4-12
5 Summary of Volatile Organic Compounds Analysis (Vent Pipe Samples)	4-13
6 Summary of Volatile Organic Compounds Analysis (Basement Air - Vent Comparison)	4-16
7 Summary of Groupings According to Detectable Methane in Basements of Townhouses	5-1



## FIGURES

	<u>Page</u>
1 Site Plan	1-2
2 Progression of the Project	3-2
3 Perimeter Venting System	3-7
4 High Block Pumping System	3-10
5 Location of Soil Probes	3-11
6 Sub-Slab Pressure Contours Unit 71	3-16
7 Continuous Methane Measurements Unit 48	4-2
8 Methane Concentrations in Three Units Over the Monitoring Period	4-4
9 Methane Concentrations in Unit 71 From April 22 to May 26	4-6
10 Unit 71 Showing Zone of Major Sub-Slab Contamination	5-7



## EXECUTIVE SUMMARY

Canada Mortgage and Housing Corporation (CMHC) owns properties and houses which have been affected by methane migrating through soils from either natural or man-made sources. In this study, the use of active soil venting was evaluated on a group of townhouses in Kitchener, Ontario to determine if this site could be effectively remediated. Methane generated from buried refuse has affected a number of homes. Various remedial solutions such as passive perimeter vents placed at the building foundations, and gas collection systems at the property boundaries have proved ineffective in controlling methane entry into basements.

In the first phase of this study, baseline methane concentrations were measured in early Spring when frozen ground conditions effectively traps soil gases, thereby, increasing the concentrations in basements. Measurements were conducted with the use of spot and continuous monitoring in a group of townhouses where previously elevated readings were recorded and where the concentration variations were well known over time. One housing block registered consistently high and explosive concentrations; another block had medium methane concentration levels and the third block was used as a control block. The readings obtained in the above units generally compared well with previous historical records with the exception of a few units.

The intention of this study was to apply active soil gas ventilation on the selected group of townhouses. Active soil gas ventilation has proven successful in mitigating radon entry into houses by as much as 99 percent. By pumping the gases out of the already existing passive vent pipes, this technology could be implemented. Testing was first conducted to evaluate the condition of the passive venting system. Unfortunately, testing revealed that major blockages existed in both the selected candidate blocks. After several attempts to clear the vents, excavation was deemed necessary. On one block, subsurface conditions revealed generally wet sandy soils which are effectively poor for soil gas transmission. The vent/riser pipes at this block were discovered to be generally poorly fitted; infilling of silt at the connections was common. The system was repaired and the trench was backfilled. At the other block, excavation was also necessary. Trenching exercises revealed wet silty geologic materials, poor for gas transmission. It was also discovered that an incomplete venting

system existed. By pumping the remainder of the system, poor performance was achieved. As such, an alternative design was required.

A series of shallow soil gas extraction wells were installed in the basements of each unit. Both active soil ventilation systems were then pumped while methane concentrations and pressures across the basement floors were recorded.

Where pumping was initiated on the block where high concentrations were recorded, good depressurization of soil gases, as well as a significant drop in methane concentrations, were observed. Further declines were observed with the installation of additional soil gas extraction wells in one of the units where previously excessive and explosive concentrations were documented. In general, favourable results were obtained.

In the block where medium concentration levels were previously recorded, a perimeter system was implemented; less favourable results were obtained. With low initial concentrations, only marginal declines in methane concentrations were realized.

Additional testing was also performed on the flue gases emitted from the fan discharges. Gases were sampled and analyzed for volatile organic compounds and carbon monoxide. Of these gases, no major concern was identified.



## 1.0 INTRODUCTION

### 1.1 Study Background

The migration of methane from either natural or man-made sources through soils into housing structures is a widespread problem. Canada Mortgage and Housing Corporation (CMHC), owns properties and houses which have existing or potential methane gas problems and as such, CMHC is interested in assessing remedial measures to minimize methane migration from soil into houses. One site which has been studied is situated in Kitchener, Ontario and will be referred to here as the Strasburg Road Townhouses. At the site, there are 81 townhouses built at the intersection of Ottawa Street and Strasburg Road arranged in 14 different blocks. The homes are all two stories with full basements, containing natural gas-fired water heaters and forced air furnaces. At the beginning of this study, all but four units were unoccupied. All units are presently owned and maintained by CMHC.

Figure 1 shows the layout of the buildings relative to the adjacent roadways and landfill site. At the time of construction of the units, it was expected that some methane problems may exist because of the presence of buried refuse. Therefore, as part of the building permit, the City of Kitchener Building Department required the developer to install passive venting systems on each housing block as well as removing any onsite refuse from beneath the foundations of the houses. The passive venting systems consisted of a 150 mm perforated plastic big "O" pipe laid next to the building foundations which were connected in 100 mm risers at the end of each housing block. However, despite these mitigative measures, elevated levels of methane were recorded forcing the evacuation of 15 families in 1976 and further evacuations thereafter.

Further to the mitigative measures at each townhouse block, methane collection systems were also installed on the landfill/townhouse property border. The methane collection systems were intended to control the migration of methane from the old landfill site. Two different systems were installed. The first one was installed in the mid-1970s. It proved ineffective. Consequently, a second system was installed in 1978. A further addition was also constructed in the playground on the CMHC property. This system known as the "playground system" was connected into the other two

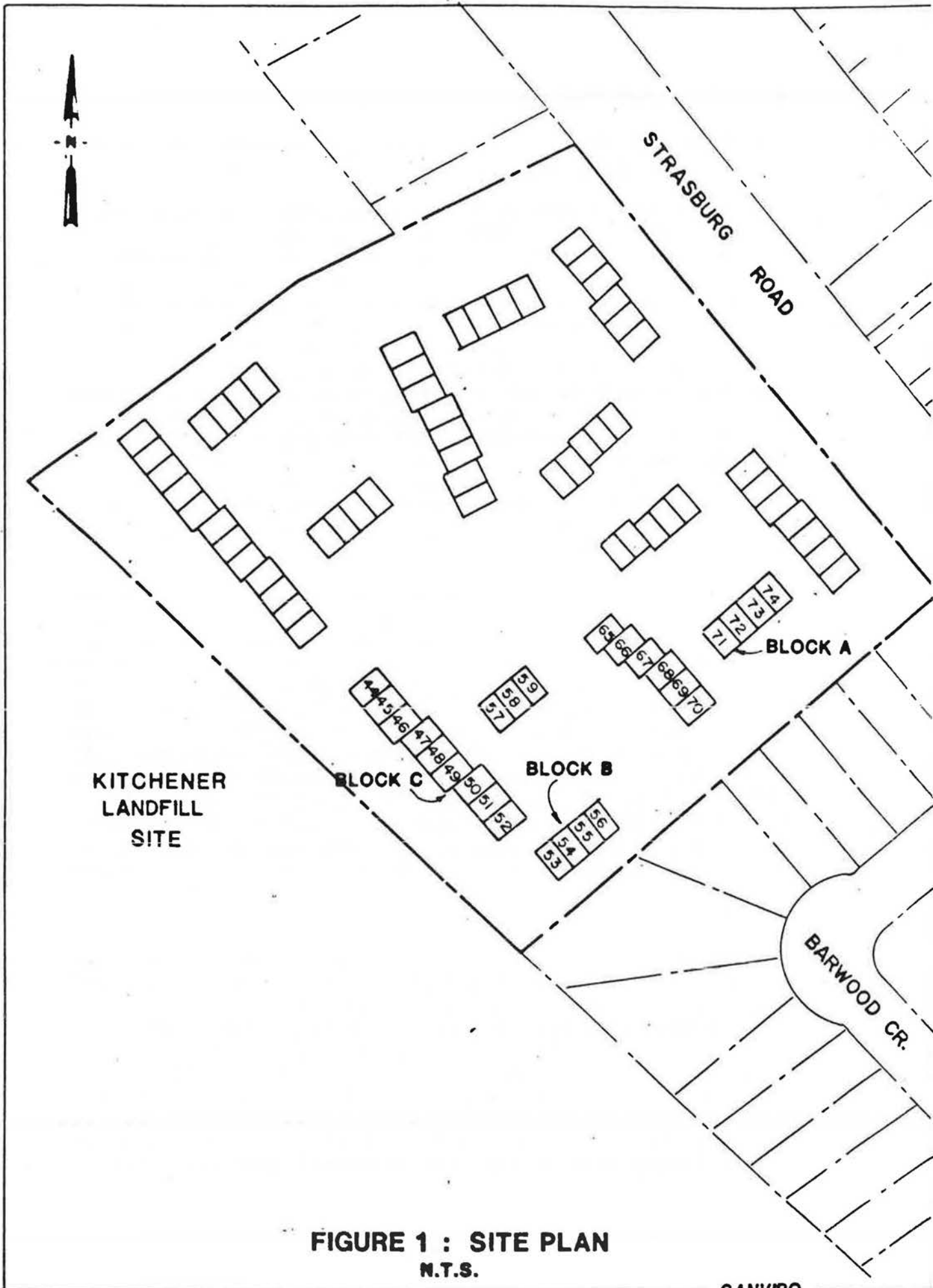

**FIGURE 1 : SITE PLAN**  
**N.T.S.**

already existing perimeter collection systems. However, despite these systems, the presence of potentially hazardous levels of combustible gas was still found in and around several of the townhouse units.

Three engineering studies have been conducted on the site over the years by different groups to evaluate methane concentrations at various locations as well as providing recommendations for remedial action. In 1984, Dominion Soil Investigations conducted an investigation and in 1986 - 1987 Morrison Beatty Limited were involved in further studies. By means of extensive monitoring and a drilling program, Morrison Beatty Ltd. (1987) concluded that the methane which was present on the site was primarily migrating from refuse which existed within property boundaries. A relatively low water table, permeable native soils as well as significant soil gas concentrations made gas migration into basements possible. In order to rectify this problem, Morrison Beatty Ltd. (1987) recommended the removal of all or part of the onsite refuse as well as the possible installation of a perimeter gas-control system. As part of that report however, Morrison Beatty Ltd. (1987) gave no consideration to technologies such as increasing the resistance of the basements to the entry of soil gas, or soil ventilation processes.

In view of the expensive remedial recommendations suggested by Morrison Beatty Ltd. and in view of the lack of consideration of alternate technologies, CMHC decided to investigate whether soil ventilation would be a favorable method of reducing the entry rate of methane into homes. Active soil ventilation is a generic term for a technology whereby the soil gas pressure around the house is reduced. By effectively modifying the local pressure distribution in and around the basement foundations, pressure gradients would be directed from the basement to the nearby soil. This would theoretically minimize soil gas entry. Although this technology has not extensively been used for methane, it has been effectively used to reduce the entry rate of radon into houses by as much as 95-99 percent. Installation costs are normally moderate, since the existing building features (e.g. coarse sub-slab fill and perimeter ventilation vents, at the Strasburg Road Townhouses) are normally sufficient to distribute an even pressure drop across basement floors and walls.

In order to investigate whether this technology might be appropriate to minimizing methane entry, CMHC retained the

services of a firm familiar with radon soil gas ventilation. Arthur Scott and Associates were retained in 1988 for the purposes of inspecting the site and making recommendations for remedial action. Based on a site visit, it was recommended that soil ventilation may in fact be technically suitable and cost-effective (Arthur Scott and Associates, 1988). Arthur Scott and Associates (1988) further outlined a procedure for testing the effectiveness of this action and would provide consultation during the testing. CANVIRO Consultants were retained for the purposes of conducting the onsite testing, and assessing the results of the investigative study. This document contains the methods used, the results and the conclusions of the field program, which was conducted from March 20 to August 4. The majority of the field work was done in a period from March 20 to May 26 with additional work conducted from July 4 to August 4.

## 1.2 Study Scope and Objectives

The study scope and objectives derived from Arthur Scott and Associates (1988), and approved by an Advisory Committee (comprised of experts from CMHC, National Research Council, Environment Canada, the Universities of Waterloo, Carleton, and Western Ontario, and the private sector) are discussed below. The major objectives were:

1. Investigate in three townhouse blocks the current conditions of the soil gas venting system, and the generation and entry of soil gas pollutants.
2. Install and monitor the effectiveness of an active venting system.
3. Investigate and analyze options to the active system; and,
4. Analyze the effectiveness of the systems designed, and their applicability to the entire townhouse project.

CANVIRO's scope of work was limited to the following:

- make spot and continuous measurements of methane
- sample soil gas and ambient air for volatile organic compounds

- purchase and install an active venting system for the townhouse blocks
- perform connectivity and permeability tests for the purpose of evaluating the condition of the venting system
- measure soil pressures and concentrations in nearby soil probes
- measure pressure and flows on the active system.



## 2.0 METHODOLOGY

### 2.1 Proposed System

Based on the recommendations from Arthur Scott and Associates (1988), it was thought that the proposed soil ventilation remedial action could utilize the present passive venting system which is in place around the existing foundations. Since relatively porous soil exists at the site, a soil depressurization of 25 to 50 Pa at the footing level was assumed to be sufficient to cause air flow from the house to the fill or soil beneath the basement floor. This would prevent the entry of soil gas and methane into the basements. Likewise any methane adjacent to the basement wells would also be collected, minimizing the potential for lateral entry. For most of the housing blocks, with the exception of two blocks furthest from the landfill site, the foundation venting systems (as described earlier) were in place. For those units without venting systems, other alternatives exist. The use of either an internal system, consisting of a single suction pipe placed through the basement slab, or a buried external system, would be sufficient to achieve depressurization. The exhaust pipes could all be connected in parallel, with one fan installed for each block of houses.

In order to evaluate the effectiveness of this form of remediation, Arthur Scott and Associates (1988) recommended sites where the pollutant concentrations were consistently elevated and the variation over time was well known. Based on previous studies by Morrison Beatty Ltd., a number of candidate houses were identified in four separate housing blocks. The candidate housing blocks included units: 1-6, 44-52, 53-56 and 71-74. Since one unit in block 1-6 was occupied and since no ventilation system existed at this housing block, only three blocks of townhouses were selected. Housing blocks 71-74, 53-56, and 44-52 were selected to evaluate the effectiveness of an active soil ventilation system. Block 71-74 was chosen because of the high recorded concentrations, block 44-52 was selected due to its proximity to the landfill site and block 53-56 was used as a control block for the evaluation. For the purposes of this study, block 71-74 will be referred to as "Block A"; block 53-56 will be designated as "Block B"; block 44-52 will be called "Block C". These designations are shown in Figure 1.

Since the highest methane concentrations are likely to occur in winter and early spring (Morrison Beatty, 1987), the test program was initiated in late March to May 26, 1989 while the soil was still moist. Moisture-laden soils at the surface can form an effective trap for soil gases, thereby, increasing methane concentrations in basements.



### 3.0 FIELD TESTING PROGRAM

The field testing program was carried out in essentially four different phases:

- i) pre-pumping phase,
- ii) active-pumping phase,
- iii) post-pumping phase,
- iv) alternative assessment phase.

Each work phase will now be discussed turn.

#### 3.1 Pre-pumping Phase

The purpose of the pre-pumping phase of the work program was to evaluate the initial conditions of soil gas venting system and the generation of soil gas pollutants within the candidate housing blocks. Tasks included:

- measurement of baseline methane concentrations
- air sampling in the passive venting stacks

Prior to any remedial action taking place, the baseline conditions could identify specific units where higher methane concentrations were evident. The candidate housing blocks (ie. Blocks A, B, and C) were monitored for methane concentrations for a fourteen day period with spot checks as well as continuous monitoring. Spot checks were carried out in each of the units of the different housing blocks whereas continuous monitoring was carried out in selected units. The duration of each of these monitoring events in the different units is depicted in Figure 2.

Instruments used in the monitoring of methane included two flame ionization detectors and one methane gas detector. The two flame ionization detectors included a Heath Detecto Pac II Organic Vapour Analyzer, and a Century Organic Vapour Analyzer Model OVA 128; the gas monitor was a Heath GMI Methane Detector. The Heath Detecto Pac II was used for the first week of spot measurements only, thereafter the Century 128 was used for all other spot measurements. For continuous monitoring, the Century 128 was used throughout



the program. Whenever methane concentrations exceeded 1,000 ppm, the flame ionization units were no longer useable; the GMI gas detector was then implemented. All equipment that was used in the field program as well as equipment specifications are documented on Table 1.

---

Table 1  
LIST OF EQUIPMENT

- Kanalflakt K-6 Fan; 325 Pa at zero flow, and 150 L/s free air (approved for this study only under special licence)
  - VAN EE Flow Master™ Airflow Measuring Equipment model FMS-06-OD; 20-120 L/s
  - Dwyer Magnahelix Gauge; 0-250 Pa
  - Dwyer Inclined Manometer; 0-62 Pa
  - Scott-Alert S109 Carbon Monoxide Meter; 0-99 ppm
  - Century Organic Vapour Analyzer Model OVA 128; 0-10, 0-100, 0-1000 ppm
  - Heath GMI Methane Detector; 0% LEL - 100% GAS
  - Heath Detecto Pac II Organic Vapour Analyzer; 0-10, 0-50, 0-100, 0-1000 ppm
  - Vaisala Humidity and Temperature Indicator HMI 31
  - Air Sampling Cannisters
  - Gastec Precision Gas Detector for Carbon Dioxide and Water Vapour; various ranges
- 

Whenever spot measurements were taken, two or three measurements were taken over a 24 hour period. These measurements were conducted in all monitored townhouses. Measurements were separated by a time span of at least 6 hours in order to ensure a complete air change within the units. Every several days, the above pattern was repeated. More frequent measurements were also conducted in units 71 and 72, due to the elevated levels detected.

Continuous monitoring was also conducted in order to identify diurnal or other short term methane fluctuations. Although continuous monitoring was not conducted in all units, due to lack of time or occasionally excessive concentrations (e.g. units 71 and 72), a representative sample was achieved in each of the three housing blocks.

Air sampling was conducted in the passive venting stacks of all the candidate housing blocks. Air samples were collected with the use of negative pressure air sampling canisters and were submitted to Environment Canada for the analysis of volatile organic compounds (VOCs). One air sample was also retrieved from a walk through the site. This integrated sample would represent ambient air concentrations in the outside air.

#### Measurement Protocol

Calibration of the instruments used for methane measurements was carried out consistently throughout the field program. Prior to any of the spot or continuous measurements, calibration of the flame ionization detectors was performed. Calibration gases of 0 ppm and 100 ppm of methane were used to tune the equipment. The Century 128 could be adjusted for both the gain and zero settings, whereas the Heath Detecto Pac II could only be adjusted for the zero setting. During the spot check of methane concentrations, readings were cross-referenced with the continuous monitor both during and after the testing. Any detected discrepancies required either recalibration or repeated measuring of the townhouse units. The Heath GMI gas meter was calibrated with a calibration gas at 49% LEL (conversion of ppm to % lower explosive limit: 50,000 ppm = 100% LEL).

Since the basements are the initial points of methane entry, all measurements were conducted in this location. In order to avoid uncertainty in the actual concentration measurements, a box fan was used to circulate air within the basements. After several minutes of circulating the air, measurements were taken at a height of 50-100 cm from the floor. The location of the fan and the spot of measurement were designated in order to ensure consistency between measurements. Most of the basements had no partitions, therefore, good circulation of air was possible. For those units where partitions remained, air circulation was achieved by placing the fan in the central access area. In so doing, no high concentration "hot spots" were identified, therefore,

it is believed an average methane value could be achieved. At all times, basement doors (with the exception of unit 55 where no door existed) were kept closed except for entry and exit.

### 3.2 Active-Pumping Phase

The active-pumping phase was initiated for the purpose of evaluating whether the depressurization of soil gases would be effective in reducing methane entry in the basements of the housing units. Tasks involved in this phase included:

- installation of basement floor slab probes,
- connectivity testing,
- permeability testing,
- repair of venting system,
- methane and pressure measurements on slab probes with active pumping in operation.

Prior to any active testing, soil gas probes were installed in the basements of every unit of Blocks A and C, as well as in unit 55. In the context of this report, these probes will be referred to as slab probes. Holes were drilled in the concrete floors into the subgrade gravel layer and a 1.27 cm CPVC pipe was installed and was set and sealed in place with a silicon seal. Refer to Figure 3 for the probe locations and schematic of a typical installation. When the soil probe was not in use, the probe was sealed with a tight fitting piece of wood dowling. These slab probes would be used for gathering information in regards to the pressure and concentration of soil gases beneath the basement floors.

Connectivity testing of the existing venting systems was aimed at evaluating the continuity of the vent pipe around the basement foundations. A continuous system of vent pipe was necessary to achieve a uniform pressure drop across the sub-grade portion of the basement structure. This test involved the installation of a Kanalflakt T-2 fan and a airflow measuring device (a VAN EE Flow Master) installed on one riser, with another airflow measuring device installed on the other risers. By performing this test, an indication of higher flow resistance in some section of the pipe would

identify either a collapsed or silt filled vent. If severe blockage was identified, alternative solutions would be in order.

Connectivity tests were performed on both Blocks A and C. The results of these tests as seen in Appendix A-14 indicated that severe blockage of the venting system existed in portions of both Blocks A and C. Blockages were discovered on Block C at riser pipes at units 52, and 44, and at Block A at unit 71. The riser pipes which were effected included: V71R, V71F, 52F, V52R and V44R (where V71R = vent at unit 71, at the rear of the building). The location of these riser pipes is shown on Figure 3.

In order to clear the vent pipes, several attempts were made to insert a motorized snake into the clogged vent pipes. Only vent V71F was able to be cleaned by this method. Consequently soil excavation was necessary. The locations of the excavated trenches is depicted on Figure 3; descriptions of the subsurface geology is described in Appendix A-13. Soil moisture was generally high, however, no ponding water occurred within the trenches during excavation. At Block C, the vent/riser pipe connections were generally poorly fitted and infilling with silt at this point was common. Specifically at units 52 and 44, the vent pipes connecting the front and back of the units were completely filled with sandy silt making the clearing of this pipe virtually impossible without a major excavation exercise. Consequently, the vent pipe connections between the front and back of this building were disconnected and new risers were installed.

Connectivity tests were again performed on Block C. Based on the results of this test (refer to Appendix A-14), good connection was established between V44R, V46R, V49R and V52R. Good airflow was also established between V52F, V49F, V46F and V44F.

After repair of the existing venting network around Block C, soil permeability tests were performed. By installing a fan at one riser pipe, the intention was to provide at least a pressure of -25 Pa in the vent pipe at the furthest point from the fan. If the soil is quite permeable, pressure losses along the pipe may require additional fans in order to achieve the same effect. The permeability testing was conducted on Block C on April 9, 1989 and again on April 24, 1989. The flow rates were adjusted with the use of in-line dampers attached to the fans. The results of the permeability test are detailed in Appendix A-14.

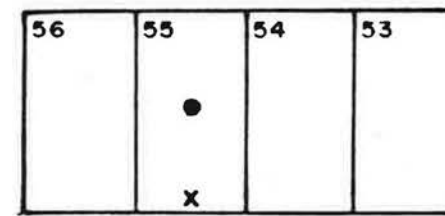
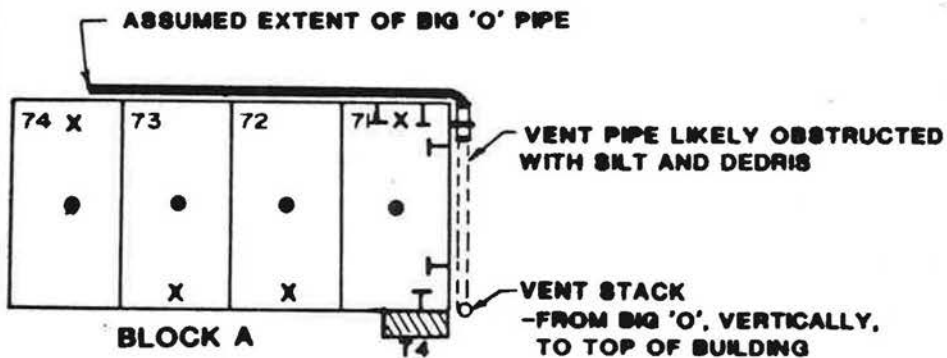

**BLOCK B**

VENT PIPE LIKELY OBSTRUCTED WITH SILT AND DEDRIS

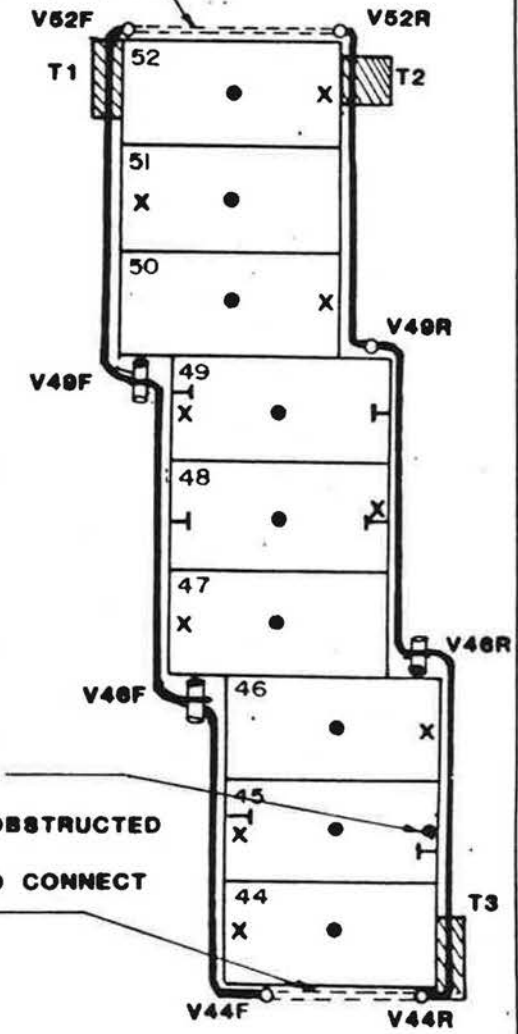

**BLOCK C**

**LEGEND:**

- O VENT STACKS
- SLAB PROBE 'A'
- X SLAB PROBE 'B'
- T WALL PROBE
- ⊕ FAN OUTLET
- ▨ EXCAVATED TRENCH
- T1

ADDITIONAL SLAB PROBE 'C'  
 ORIGINAL VENT PIPE LIKELY OBSTRUCTED WITH SILT AND DEDRIS  
 TEMPORARY INSTALLMENT TO CONNECT SYSTEM (ABOVE GROUND)

**FIGURE 3: PERIMETER VENTING SYSTEM**  
**N.T.S.**

Based on the results of the permeability tests, it was apparent that a total of three fans were required for Block C. Since greater soil pressure losses were incurred in the front of the housing block, it was necessary to place two fans at locations V49F and V46F respectively. An additional fan was installed at the rear of Block C at V46R. Since pressure losses were minimal along the rear of this block, only one fan was required. All fans were equipped with dampers so that the desired pressure could be achieved. All other vent pipes were capped. It should also be noted that although the equipment used in this test was effective, the equipment was implemented under a special licence. Later certification tests on the Kanalflakt fan by Canadian Standards Association indicated that this Kanalflakt fan was unsuitable for this application. Therefore, it is not recommended for similar uses elsewhere.

Active pumping was first initiated on Block C on April 15. Since pressures in Block C riser pipes developed to rather excessive values, ie. much greater than -25 Pa, the pressures were dropped by closing the dampers on all three fans on April 17 at 17:00. This action reduced the negative pressures at the various riser pipes to more acceptable levels. Later on April 24, the pressures were reduced again by the removal of a fan from V46F and by making a temporary connection between V44F and V44R. The temporary connection was achieved by routing a 100 mm non-perforated Big "O" pipe along ground surface from V44F to V44R. A minimum of -25 Pa was still achieved at all riser pipes with the damper position closed at V46R and fully open at V49F. Vent pressures observed are documented in Appendix A-9.

Connectivity tests also identified problems at the venting system of Block A. Excavation was again necessary. Upon the excavation of trench T4 (beside unit 71), no venting pipe was discovered. Only a 100 mm plastic clogged weeping tile was identified at the foundation level. The weeping tile was cleared, repaired and the excavation was filled in. The motorized snake was then forced with great effort into V71R. A total of 23 metres of snake was inserted into the vent pipe before refusal was encountered. Since no vent pipe existed in the rear of the building (at trench T4), an assumed extent of the vent pipe could be determined to the front of the building. Refer to Figure 3. When the snake was withdrawn, however, collapse of silt at V71R reoccurred. A connectivity test was again performed by attaching a fan to V71F, however no connection at V71R was discovered. The fan was then operated for a period of 12 hours to see if



some depressurization would occur in the slab probes; however no depressurization was discovered in any of the slab probes. Based on these results, it became apparent that the existing venting system in Block A was of negligible use.

As an alternative to the venting system at the foundation level, a series of shallow basement soil gas extraction wells as previously recommended by Arthur Scott and Associates (1988) was installed in the units of Block A. The piping layout is shown on Figure 4. Initially only one extraction well was installed per basement. At a later date when alternative assessment was taking place, an additional well was added to unit 71.

Several types of measurements were conducted during this phase of work:

- spot and continuous methane measurements of basement air.
- spot methane measurements of soil probes.
- pressure measurements across basement slabs and at riser pipes.
- carbon monoxide concentrations in both ambient basement air and basement slab probes.
- VOC sampling in the vent stacks.

Methane measurements were carried out before, during and after the pumping system was activated in Blocks A, B, and C. Protocol for measuring methane was similar to that described in the previous section in the pre-pumping activities. As well, calibration was carried out in a similar fashion.

Soil gas methane measurements were also conducted outside the homes for the purpose of identifying trends. Several previously installed gas wells were used for this purpose. Due to the high gas concentrations encountered, all measurements were conducted with the use of the GMI. The soil gas wells will be referred to in this report as soil probes; the locations of these probes are shown in Figure 5.

Pressure measurements were carried out on slab probes with the use of an inclined manometer. Prior to the activation of the fans, baseline slab pressures were recorded.

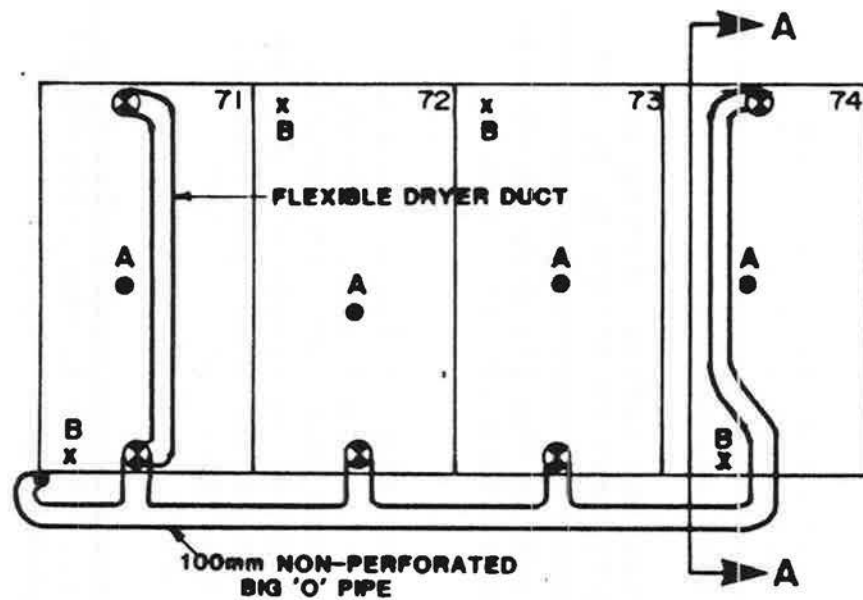

**PLAN**

**LEGEND**

- ⊗ PUMPING WELL
- SOIL PROBE 'A'
- X SOIL PROBE 'B'

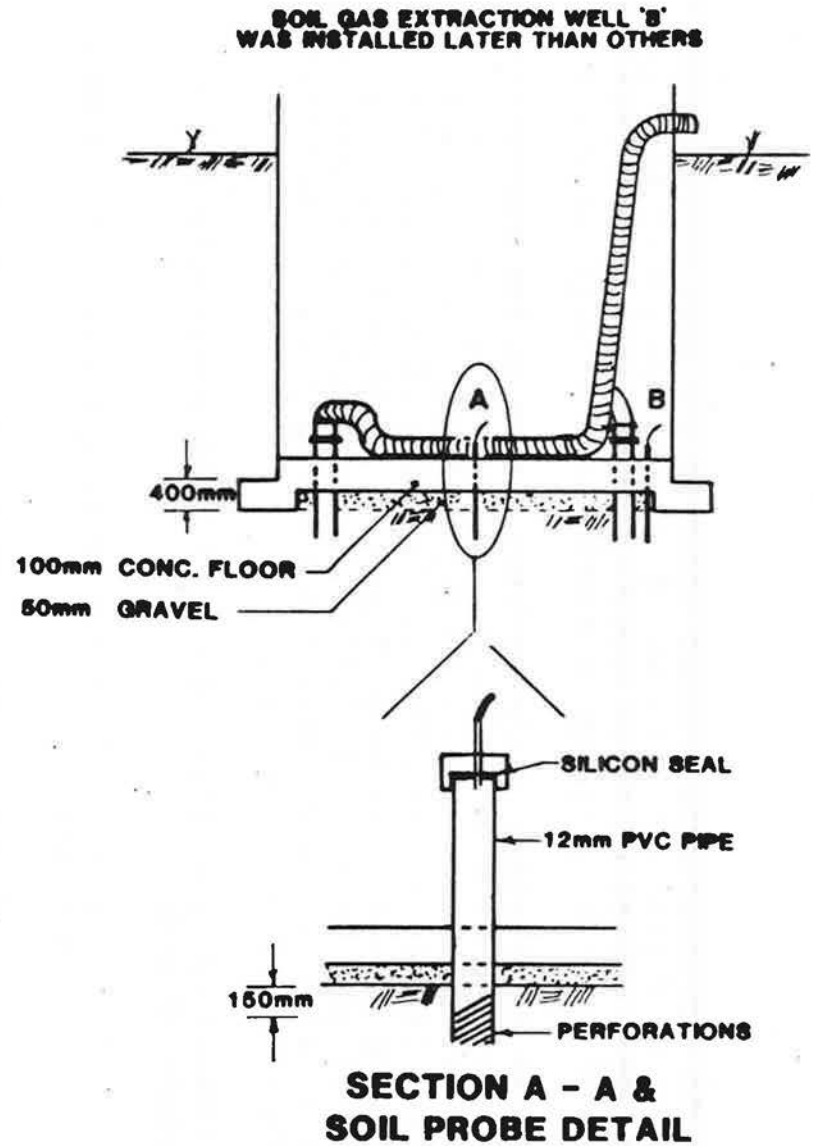

**FIGURE 4 : SCHEMATIC OF SOIL GAS EXTRACTION WELLS**

N.T.S.

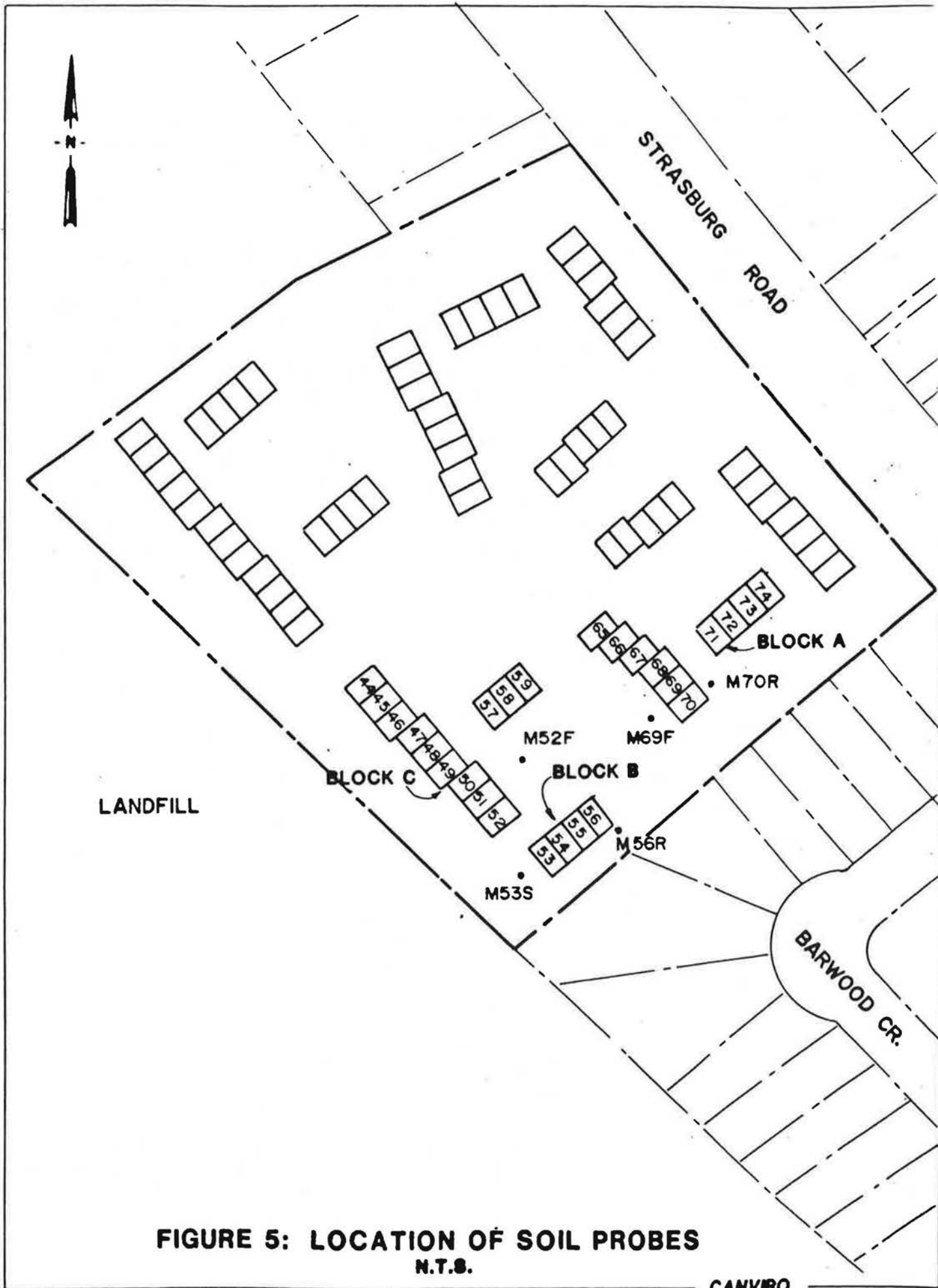

**FIGURE 5: LOCATION OF SOIL PROBES**  
**N.T.S.**

Periodic measurements were then performed during pumping at both the slab probes and riser pipes. Monitoring of these pressures enabled the evaluation of sub-slab pressures and the suction potential in the vent pipe system. A minimum of -25 Pa was ensured in the vent pipe during the active pumping phase.

Carbon monoxide (CO) was also monitored in the basements of the candidate units, in the vent pipes, and in some of the slab probes. Carbon monoxide, which is sometimes associated with older landfill gases, was sampled with a Scott-Alert S109 carbon monoxide meter. The meter was zeroed at a location several kilometres from the landfill, in an open area, in order to minimize landfill influences.

Air sampling at the various vents was again conducted with negative pressure canisters while the fans were in operation. Pressure taps which were installed into the exhaust vents at V71F and V49F, and also at the passive vent V56F of the control block, provided a connection for direct in-line sampling. An integrated sample was collected during a walk through the site. The samples were then submitted to Environment Canada for VOC analysis.

### 3.3 Post-Pumping Phase

The post-pumping phase was aimed at establishing the rate of methane build-up in the case of a fan or power failure. In order to simulate this event, the Kanalflakt fans were shut down and the methane was monitored before and after the fan shut-down.

A summary of the work tasks in this phase included the following:

- spot checks and continuous monitoring of ambient methane levels in basements,
- installation of wall probes,
- spot checks of slab and wall pressures,
- spot checks of CO concentrations,
- air sampling for VOCs in passive vents.

The fan shut-down procedure on Block C occurred on May 1 at 13:00. The fans were then left idle until May 11 when the

riser pipes were capped. Fan shut-down procedures on Block A were initiated on May 3 at 11:00. For Block A, the Kanalflakt fan was restarted on May 5 at 11:00.

Methane levels, which were measured before and after shut-down of the fans, were carried out according to the protocols outlined in Section 3.1. During the shut down procedure in Blocks A and C, the continuous monitor was installed in units 48 and 71 where previously the highest methane levels were detected. Continuous monitoring continued for a total of 24 hours, which represents a reasonable maximum time period for a power outage.

During this work phase, additional gas probes were installed along several walls in units 71, 49, 48 and 45. The purpose of installing these probes was for the purposes of assessing the magnitude of pressures developed on the exterior of the basements walls both before and after pumping. In this manner, possible entry mechanisms of methane might be more precisely determined. Installation of these wall probes was similar to the installation of the floor probes described in Section 3.2. During this work phase, slab pressures across the floors and walls were checked before and after fan shut-down.

Carbon monoxide (CO) concentrations were again monitored during this work phase, for the reason given early. Carbon monoxide was measured in both basement air and in selected slab probes in Blocks A and C. After this work phase, CO measurements were discontinued.

Air sampling was conducted in a similar manner as described earlier. Samples were again submitted to Environment Canada.

#### 3.4 Alternatives Assessment Phase

The purpose of the work phase was to initiated to optimize system performance and to determine several unresolved issues. The unresolved issues included concerns raised by Arthur Scott and Associates (1988), the Advisory Committee and concerns which were encountered during the work program. The following list of issues was addressed during this work phase:

1. What minimum negative system pressure is required to achieve satisfactory performance?

2. What is the radius of influence of the soil ventilation system?
3. Will the soil ventilation system cause oxygen enrichment and subsequently result in a subsurface fire?
4. Would a fan or power failure during a rainfall event cause excessive methane levels to develop?
5. Would sub-slab pressurization cause an equivalent decrease in methane concentrations as experienced with sub-slab depressurization?
6. How do VOC concentrations in the vent stacks relate to VOC concentrations present in basements?

These concerns were addressed by the following tasks:

- increases and reductions of the venting system pressures on both Blocks A and C and a monitoring of methane levels
- monitoring of soil probes and vent discharges for pressure and methane concentration in the vicinity of the venting system
- monitoring of moisture content and carbon dioxide concentrations in the vent gases and in nearby soil probes
- simulation of fan failure during rainfall activity, with continuous monitoring of methane levels
- reverse flow direction of fan in order to pressurize sub-slab gases thereby creating a high pressure front
- collection of air samples from ambient air in basements and analyze for VOCs

#### Evaluation of Sub-Slab Depressurization

In order to determine the minimum negative system pressure necessary for satisfactory performance, the suction pressures were varied on both Blocks A and C. The decreases in suction pressures in Block C were achieved by closing the dampers which were installed at each fan outlet. Details

are given in Section 3.2. Unfortunately, due to relatively low initial methane concentrations detected in Block C, a conclusive minimum criteria was difficult to establish. Therefore, one unit in Block A was used to establish this minimum criteria.

In order to determine the minimum system pressure, unit 71 was selected due to its historically high methane concentrations. Initially, when the first soil gas extraction well was installed in the basement of unit 71, a large decrease in methane concentration was documented. However, despite the decreases in concentrations, continuous monitoring in unit 71 revealed that significant diurnal variations (of approximately 60 ppm) were still possible. Excessive diurnal variations of this sort may indicate zones of low permeability beneath the basement floor slabs probably due to water content (Arthur Scott, personal communication). To identify these areas of low permeability, holes were drilled through the basement floors. A smoke pencil was used to identify that gradients were in fact downward at all locations in unit 71 across the basement floor slab. Slab probes were then installed in order to monitor the degree of depressurization across the basement floor of unit 71. The location of the slab probes in unit 71 and the depressurization achieved with one vapour extraction well is shown in Figure 6.

As seen in Figure 6, with only one soil gas extraction well, there was a distinctive lack of depressurization across the entire basement floor. Such poor depressurization indicates that the sub-slab geologic matter has properties likely of relatively low permeable materials. Low permeability may be caused by silty, clayey materials or high moisture content. Observations during the trenching operation of T4 and later during the installation of an additional soil gas extraction well in unit 71 (refer to Appendix A-13) indicated both silty and wet conditions.

In view of the poor depressurized conditions in unit 71, an additional soil gas extraction well was installed. By pumping the two extraction wells in unit 71, a mid-floor depressurization of -25 Pa was achieved at slab probe A. This readjustment of pressure minimized the previously experienced diurnal variations. The revised pressure pattern is shown in Figure 6.

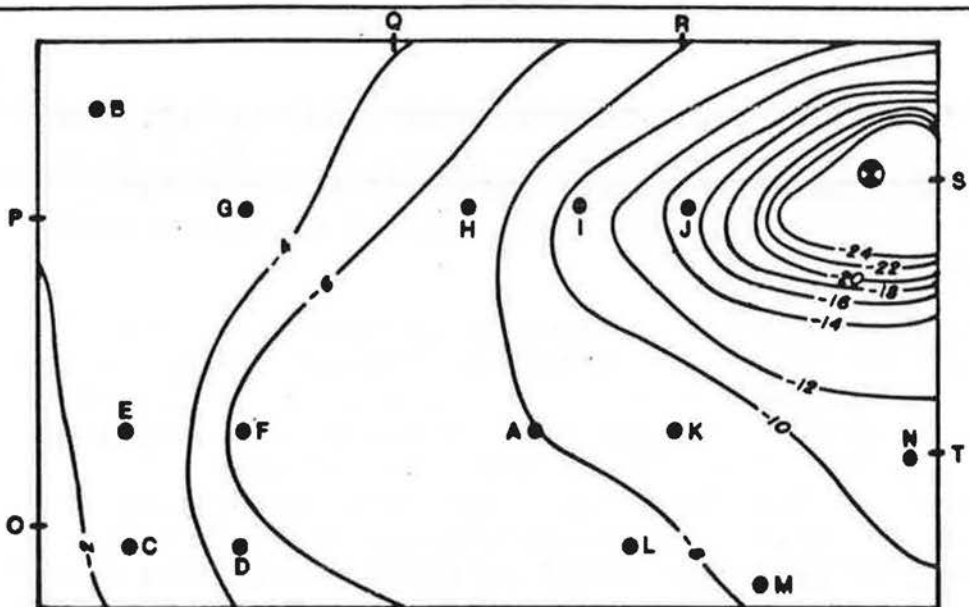

PRESSURE CONTOURS WITH ONE VAPOUR WELL (MAY 25)

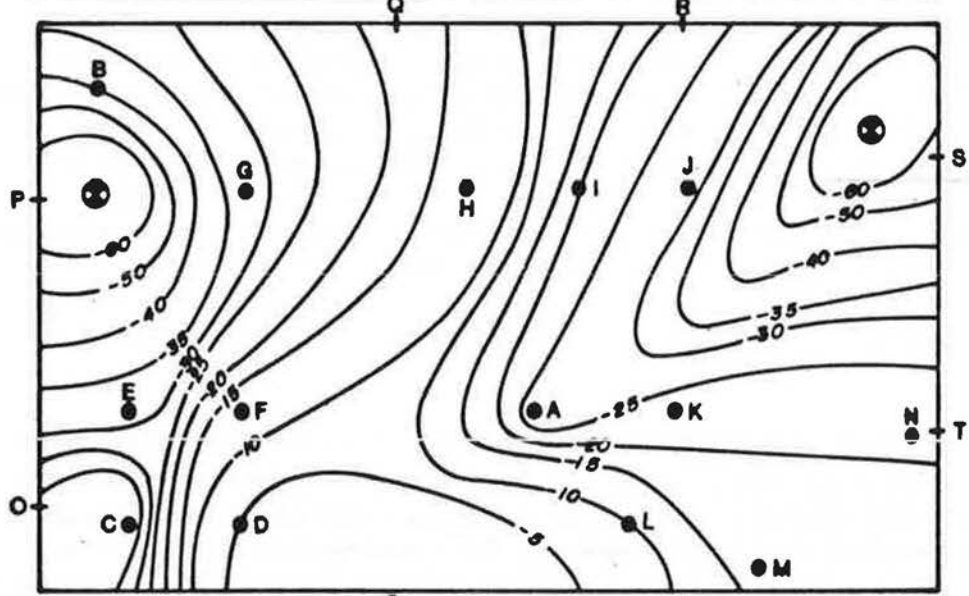

PRESSURE CONTOURS WITH TWO VAPOUR WELLS (MAY 2)

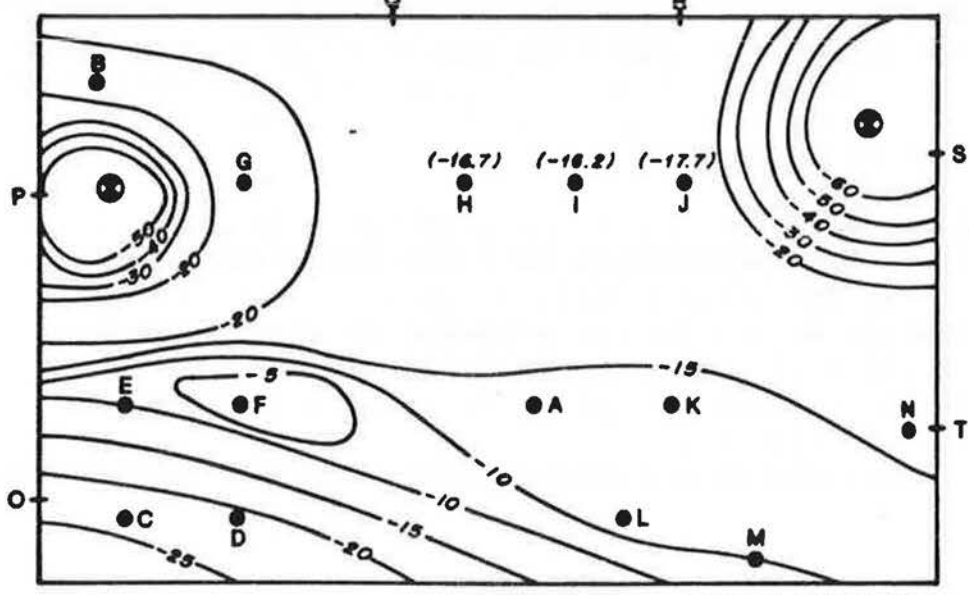

PRESSURE CONTOURS WITH REDUCED SUCTION (MAY 8)

-12.0 - EQUIPOTENTIAL LINES (Pa)  
 ⊗ - VAPOUR EXTRACTION WELL

FIGURE 6: SUB-SLAB PRESSURE CONTOURS UNIT #71



After active pumping of Block A had ceased and was again restarted, the suction pressure was reduced. On May 8, 1989, suction pressures were reduced to a level of approximately -15 Pa at a mid-floor location (refer to Figure 6). Continuous methane measurements were carried out throughout system adjustment.

### Radius of Influence

The radius of influence from the soil ventilation system will be dependent on several factors including:

- the location of the pumping well or vent relative to porous geologic material
- moisture content/permeability of surrounding soils
- methane production from nearby refuse
- pumping rates and suction pressure
- presence or absence of a surface confining layer

Since many of the above factors are unknown and quite variable in time and space, the prospect of determining a definitive zone of influence from the vapour extraction system is quite remote. Nevertheless, a limited program was initiated. Two influence tests were performed on Block A pumping system; no influence tests were conducted on Block C. One test involved the shut down and restarting of the Block A pumping system. Vapour pressures were monitored for a short period of time at a nearby soil probe, M70R. The other influence test involved a semi-quantitative evaluation of the various pumping wells between the various units.

### Oxygen Enrichment

Another concern which was raised, with respect to the soil ventilation concept, was the introduction of oxygen to the subsurface and the possibility of a subsurface fire. In order to evaluate whether oxygen enrichment was in fact a problem, flue and soil gases were monitored for both temperature and carbon dioxide content in the vicinity of Block A. If greater aerobic digestion and/or combustion was initiated as a result of oxygen enrichment, higher concentrations of CO<sub>2</sub> and a rise in temperature should be documented. The results in the early parts of this program were likely limited, since the moist soil conditions would gener-

ally limit oxygen entry into the subsurface. Monitoring over an extended dry period gives a better indication of CO<sub>2</sub> and temperature trends. Monitoring of CO<sub>2</sub> and temperature was conducted until July 24, 1989.

### System Failure Simulations

During the course of the investigation, it became apparent that the most significant methane levels and soil gas pressures occurred during and after precipitation events. Hence, if a system failure occurred either due to power outages or mechanical fan failure during or slightly after the beginning of a precipitation event, elevated methane concentrations may be evident in the basement air. Although the candidate blocks were both tested for methane concentrations in the post-pumping phase, system failures were not timed at the exact time of a precipitation event. Further fan shut-downs were therefore initiated for the purpose of determining the rate at which methane concentrations might increase at a time of a precipitation event. Failure scenarios were conducted on Block A only. The fan on Block A was also rerouted and connected to the riser stacks for this test. Therefore, the additional effect of stack suction could be observed.

The first fan failure was initiated on May 23 for a shut-down of five hours. The second fan failure simulation occurred on May 25-26 for a 21 hour period. Although these tests were not representative of the absolute worst environmental conditions, they can give an indication of typical system response. It should also be noted that the simulated power failures conducted in this study exceeded typical power outages reported by the local utility. The maximum power failure duration reported by the local utility at this site was 84 minutes in the last 2-1/2 years (refer to Appendix B-1).

### Evaluation of Sub-Slab Pressurization

During discussions with the Advisory Committee after the completion of depressurization work, concerns were raised about possible odours emitted by the active soil ventilation system. As a solution to this problem, the implementation of sub-slab pressurization was suggested. CANVIRO in cooperation with Arthur Scott and Associates performed the required field work in a period from July 4 to August 4, 1989.

The pressurization concept was implemented on both Blocks A and C. For Block A, one Kanalflakt fan was used to inject air below the basement floors by means of the individual wells which had previously been installed. In the case of Block C, two Kanalflakt fans were installed, one at location V49F and the other at V46R. The temporary connection between V44F and V44R was also used. Spot methane concentrations and pressure measurements were conducted at various times throughout the monitoring period.

In addition to the units which were monitored during the earlier phases of work, eight other units in the vicinity of Block A were monitored to evaluate the effects of methane migration.

#### VOCs in Ambient Basement Air

As part of the field program, air sampling was conducted at three different times: before, during and after the active soil ventilation system was activated. Sampling on each occasion was conducted at an exhaust vent at each of the housing blocks, and on the outside ambient air at the townhouse site. During a subsequent meeting with the Advisory Committee, a concern was raised on the possible correlation of such data with actual VOC concentrations in ambient basement air.

Due to a lack of data in the literature, an additional sampling round was conducted at the site on August 7, 1989. To conduct this test, a group of units in housing Block C were chosen. The housing units in Block A were rejected for this test since numerous slab probes had been recently installed. The silicon sealant used in the installation could introduce airborne contamination not native to the site.

Air samples which were taken in each of the basements were sampled by means of the cannister method. The ambient air was initially circulated by means of a box fan. After sufficient circulation of approximately 10 minutes, the cannister valve was opened to draw in the required volume of air. Sampling times lasted approximately 10 minutes.

Air samples taken at the exhaust vent was done in a similar fashion as described in Section 3.2.



## 4.0 RESULTS

The results of the work program described in the previous section will be described in terms of the key parameters that were measured during the investigation. Each of these parameters will now be discussed in turn.

### 4.1 Methane

Methane concentrations were recorded throughout the field program by both spot checks and continuous monitoring. An example of a continuous record is depicted in Figure 7. Primarily methane concentrations were determined with the use of the Century 128 Organic Vapour Analyzer (OVA) and the Heath GMI Methane Detector. As previously mentioned, for methane concentrations greater than 1,000 ppm, the GMI was used, whereas levels less than 1,000 ppm, the OVA was utilized. Methane concentrations in the basement air are summarized in Appendix A-1; methane concentrations in the flue gases and soil monitors are summarized in Appendix A-2; methane concentrations below basement slabs are summarized in Appendix A-3. All values which appear on the tables in Appendices A-1, A-2 and A-3 given in terms of ppm were recorded with the OVA. Values given in terms of the lower explosive limit or percent gas were detected with the GMI.

Conversions between these scales are as follows:

$$50,000 \text{ ppm} = 100 \% \text{ Lower Explosive Limit (LEL)} = 5\% \text{ GAS}$$

As described in the protocol for equipment calibration, the OVA and the GMI were calibrated against known standards. When calibration of the OVA had taken place, instrument readings were always within  $\pm 10\%$  of the full scale deflection. Readings on the OVA were adjustable to several different ranges: 0-10 ppm, 0-100 ppm and 0-1,000 ppm. A 10% error in the reading was more common at the lower ranges. Calibration of the GMI showed no significant error.

The methane concentrations which were recorded during the field program were highly variable and were dependent on time of the day, location, antecedent precipitation events, and soil gas pumping activity. The highest methane levels were identified in units 71 and 72 with the lowest values recorded in units 52, 47, 46 and 44. The highest concentrations in the control block were registered in unit 55.

# Continuous Monitoring Unit 48

(active pumping measurements)

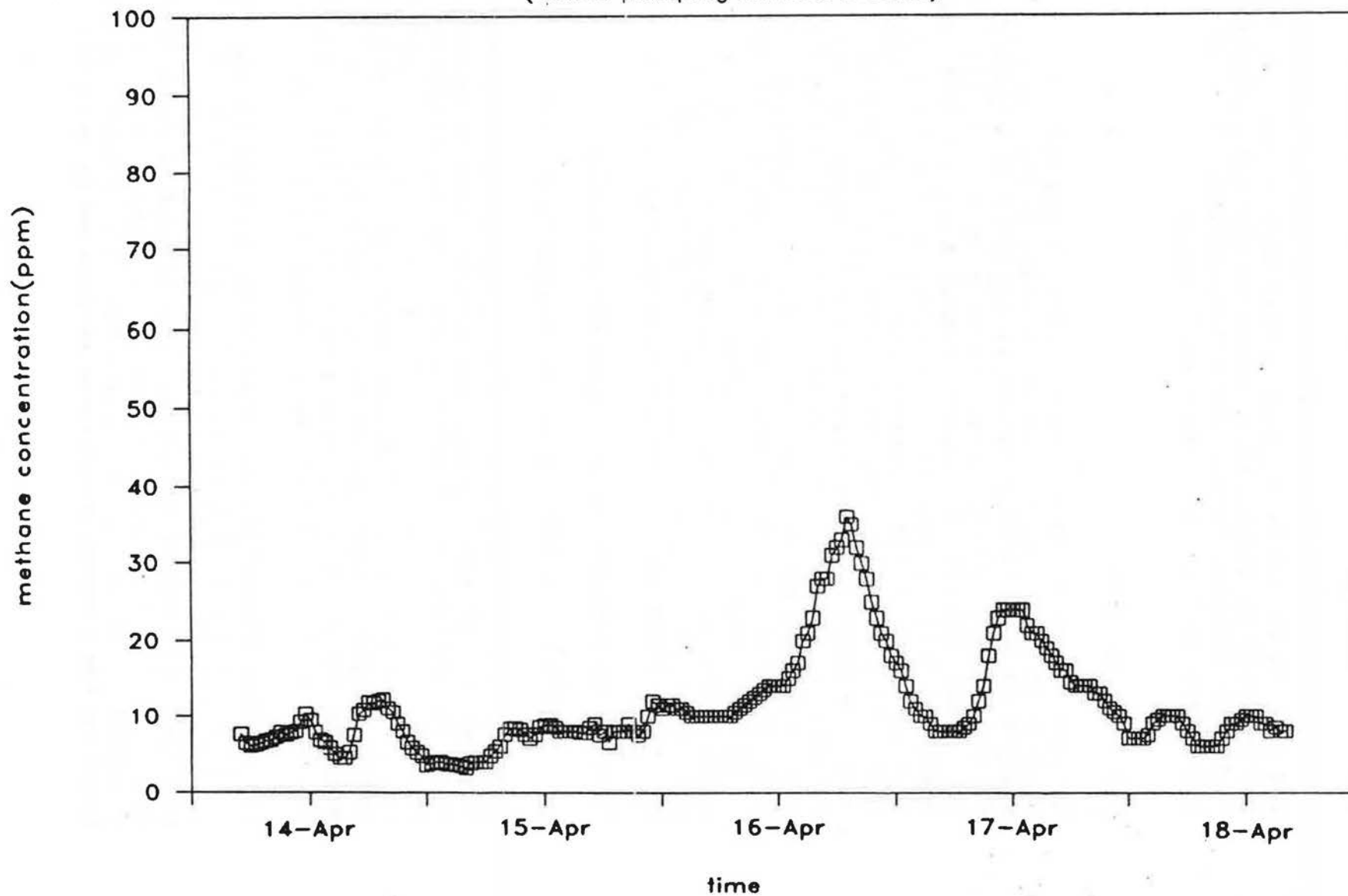

**FIGURE 7: CONTINUOUS METHANE MEASUREMENTS UNIT 48**

Methane concentrations are summarized for the first three work phases on Tables 2 and 3 for the three candidate blocks respectively. A representative sample from each block is also included in Figure 8.

Table 2  
METHANE CONCENTRATION RANGES IN BLOCKS A AND B

Unit #	Pre-Pumping Phase (Mar 21 @ 12:30 - Apr 18 @ 15:30)	Pumping Phase (Apr 18 @ 15:00 - May 3 @ 11:00)	Post-Pumping Phase (May 3 @ 11:00 - May 5 @ 10:00)
<b>Block A</b>			
74	4-100	1-7	2-100
73	8-350	1-13	2-125
72	11-4650	1-30	1-3650
71	16-27500	2-65	80-4600
<b>Block B</b>			
56	1-13	1-9	2-5
55	12-70	6-35	14-50
54	2-19	1-9	2-7
53	2-23	1-8	1-5

(All concentrations in ppm)

Table 3  
METHANE CONCENTRATION RANGES IN BLOCKS B AND C

Unit #	Pre-Pumping Phase (Mar 21 @ 12:30 - Apr 13 @ 17:25)	Pumping Phase (Apr 13 @ 17:25 - May 1 @ 13:00)	Post-Pumping Phase (May 1 @ 13:00 - May 12 @ 15:00)
<b>Block C</b>			
52	1-14	1-8	1-4
51	2-12	1-7	2-7
50	1-10	1-9	1-5
49	3-16	3-16	2-9
48	10-50	3-36	8-110
47	1-10	1-6	1-5
46	1-11	1-10	1-4
45	2-11	1-8	3-10
44	1-10	1-7	1-6
<b>Block B</b>			
56	1-13	1-9	2-6
55	12-70	10-35	8-40
54	2-19	1-9	2-7
53	2-23	1-8	1-5

(All concentrations in ppm)

**Note: Each graph has a different scale**

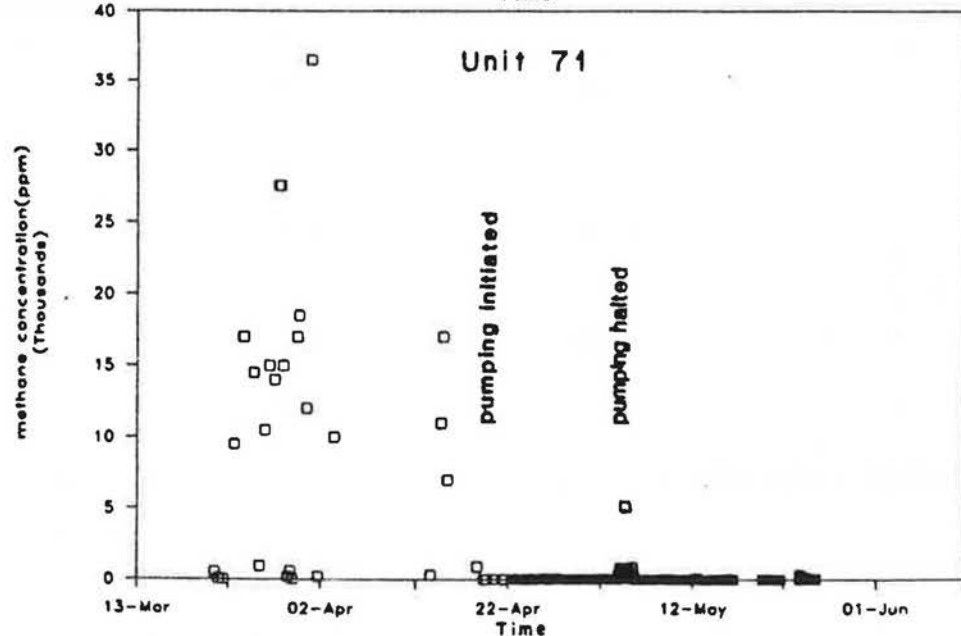
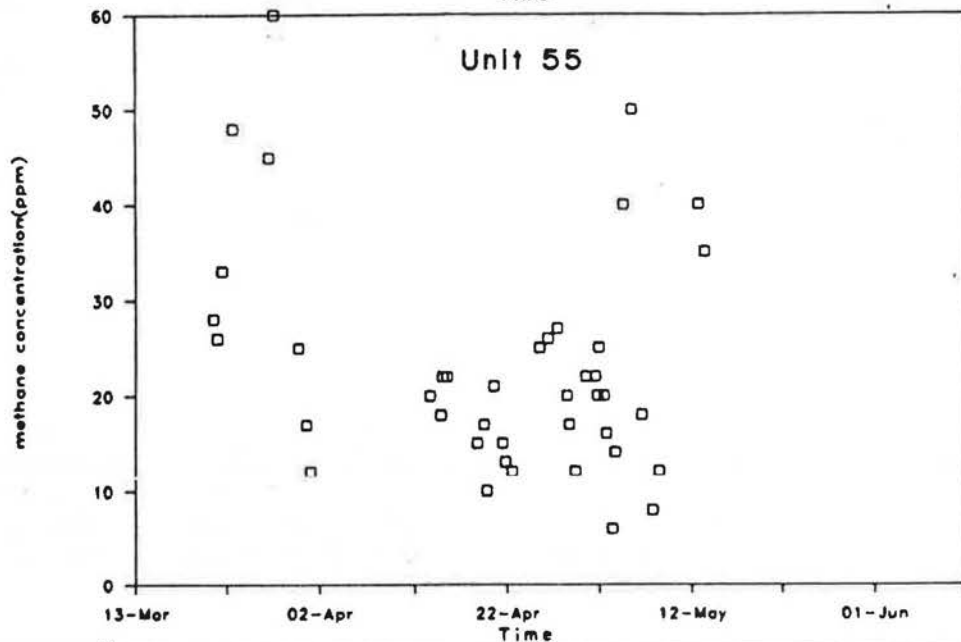
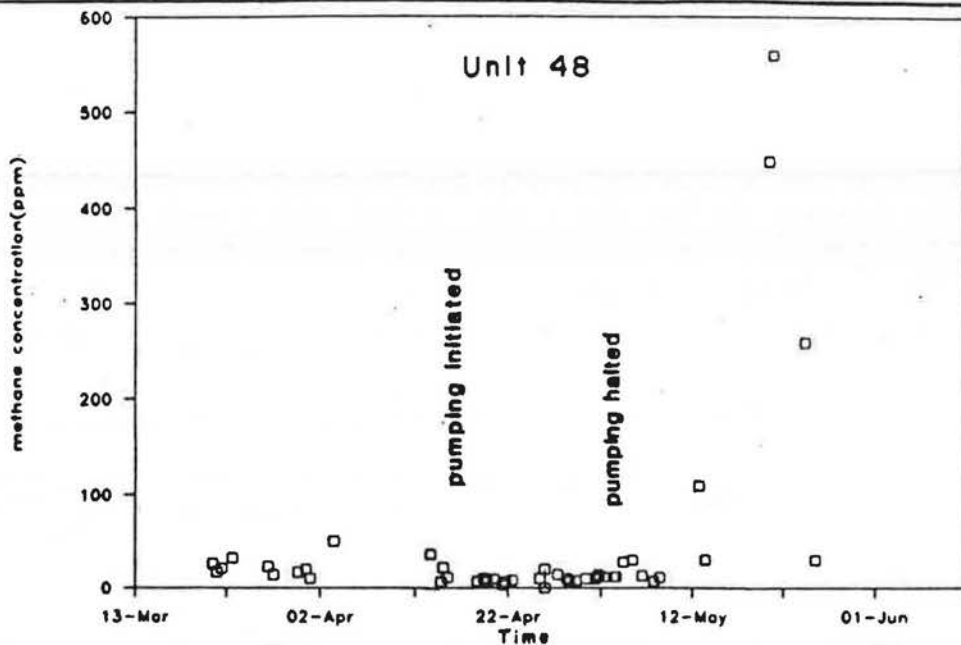

**FIGURE 8: METHANE CONCENTRATIONS IN THREE UNITS OVER THE MONITORING PERIOD**



Based on the results shown in Tables 2 and 3, and Figure 8, it is apparent that the methane concentrations in each of the housing blocks could be highly variable with respect to the time of sampling during the monitoring period. By comparing the scales on each of the graphs in Figure 8, it is also apparent that large differences may also exist between the various housing blocks.

The methane concentrations, as recorded in unit 48 as seen in Table 3 and on Figure 8, registered generally little change with the installation of the soil ventilation system. This pattern was also true for most of other units in the same block. After the pumping was shut down on May 1, methane levels rose only slightly. However, after the risers were capped on May 11, abnormally high concentrations were then identified in several of the units. After the reconnection of the risers, the values again declined giving similar concentrations which had previously been experienced.

Methane levels as recorded in the control block showed a slight decline with respect to time. Large increases due to rainfall events were typical throughout the monitoring period. In general, however, the methane levels were low.

The most dramatic changes in methane concentrations occurred in Block A when depressurization was implemented. In the pre-pumping monitoring period, methane levels fluctuated greatly from 4 to 27,500 ppm (55% LEL) in the basement air. The highest concentrations were recorded in unit 71. With the initiation of pumping on April 18, methane levels dropped drastically as shown in Figure 8. With the soil gas extraction well in operation, continuous monitoring revealed that diurnal variations between 10 and 65 ppm still occurred within unit 71. Refer to Figure 9. As a result of adding an additional well in unit 71 on April 27, notable decreases in methane concentrations were noted as seen on Figure 9. Upon system shut down on May 3, methane concentrations rose slowly from 6 ppm to 800 ppm in 16 hours. Thereafter a decline was documented. The decline continued until a rise in concentration was recorded coincident with a precipitation event on May 4. Concentrations rose to at least a value of 4600 ppm (beyond the range of the continuous monitor) at which time the pumping system was restarted. Ambient basement methane concentrations declined immediately. Generally low concentrations were recorded thereafter except for a pumping system layout adjustment on

Note: Each graph has a different scale

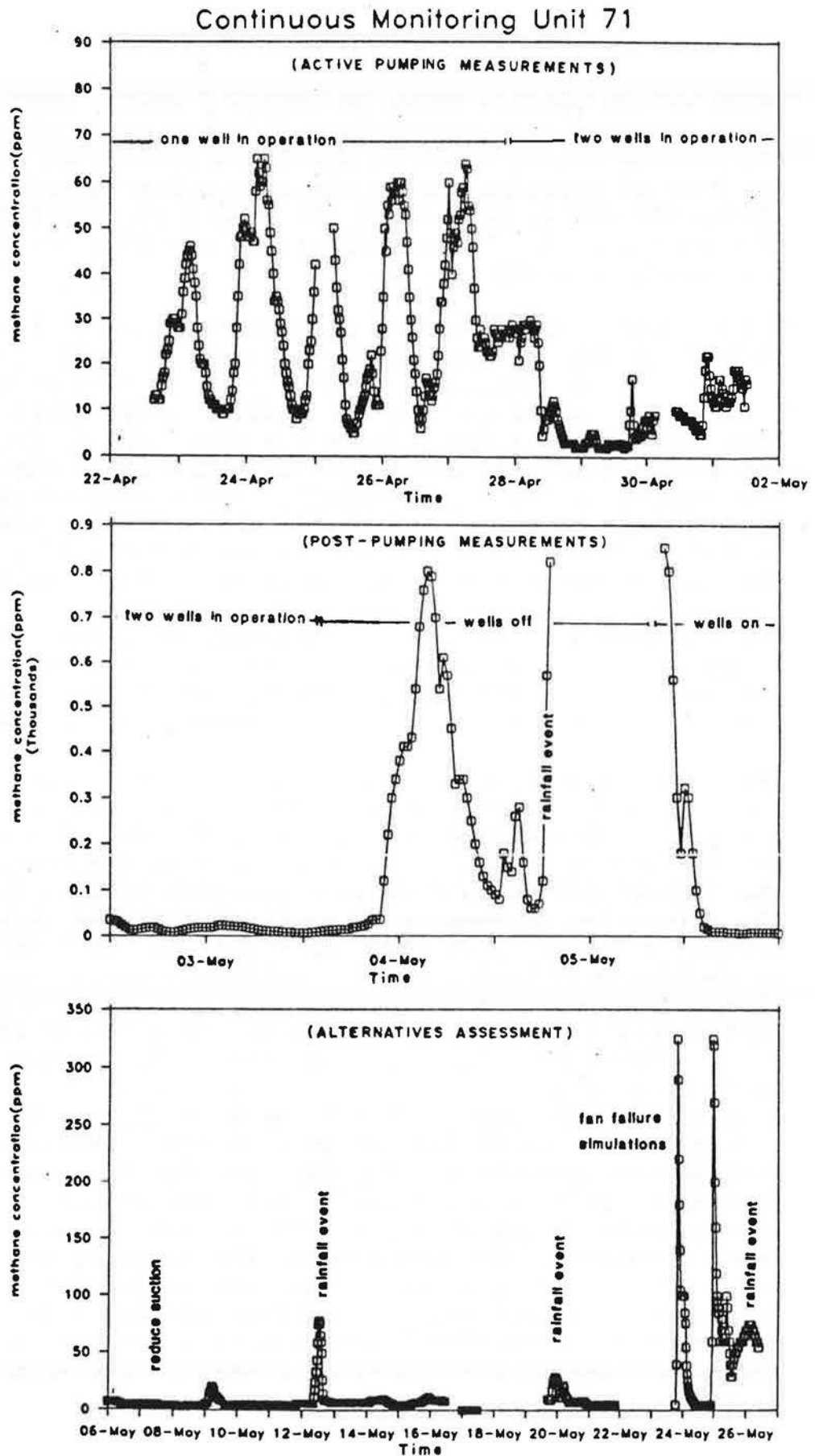

FIGURE 9: METHANE CONCENTRATIONS IN UNIT #71 FROM APRIL 22 TO MAY 26

May 10 and a significant rainfall event on May 12. Another rainfall event on May 20 produced only slight increases in the methane concentrations.

As part of a failure scenario exercise, the fans were shut down during the peak of a rainfall activity on May 23 and May 25. The methane concentrations rose quickly during the May 23 storm event but declined thereafter without the influence of pumping. The fan was restarted and pumped for a short period. Thereafter another fan failure was simulated, causing methane concentrations to rise quickly. Concentrations declined again without the influence of pumping. These declines had not previously been documented when the riser pipes were not connected. Early on May 26, a thunder shower deposited 10 mm of rain which in turn caused only slight concentration increases.

Methane concentration trends recorded in the venting system risers closely resembled ambient basement concentration trends. Whenever high basement concentrations were recorded, vent concentrations were also equivalently higher. Vent methane concentrations varied anywhere from 1.0 ppm in V46F to 9000 ppm (18% LEL) at V71F whenever the pumping system was in operation. Changes in vent concentrations generally responded to increased soil gas pressures. Soil gas pressures can be influenced by barometric pressure, wind, precipitation events or subsurface drainage such as a falling water-table elevation. As in the case of V71F, whenever the nearby soil gas pressure in M70R increased, higher gas concentrations were identified in the flue gases of V71F (refer to Appendix A-5).

Several of the soil probes measured significant levels of methane. Monitors M70R, M69F, and M53S registered maximum levels of 71% GAS, 97% GAS and 50% GAS respectively. Each of these monitoring locations were sampled for extended periods of several minutes. No declines in concentrations were noted, therefore, indicating sizable methane sources. For those soil probes with lower methane concentrations such as M52F and M56R, increases were only observed whenever excessive precipitation had occurred. Higher methane concentrations were observed at these locations in the vicinity of the May 5 and May 12 rainfall events. At these monitoring wells, a limited supply of methane was generally available. When sampled, concentration measurements would rise quickly and then would proceed to decline. This indicates a limited supply of methane was available for pumping.

Methane concentrations were also monitored in the slab probes before, during and after system shutdown in housing Block C. The results of these measurements are included in Appendix A-3. In Block C, concentrations in the slab probes rose only slightly in some of the units after active pumping was halted. Slightly increased concentrations were noted in the slab probes located in units 52, 48, and 45. Despite the rainfall encountered on May 2, no significant methane concentration increases were documented in the slab probes in Block C.

Methane concentrations measured in the slab probes in Block A during system shutdown, however, showed considerable variation. As seen in Appendix A-3, methane concentrations were rising late in the day on May 1. By May 2, significant concentrations were identified in units 73 (probe B), 72 (probe B) and 71 (probes G, H, I, J, N). By May 3, the concentrations had dropped slightly. However, as soon as the pumping system was shut down, concentrations under the slabs rose very quickly. A rise of methane was soon identified in the ambient basement air of all units within Block A.

The effect of sub-slab pressurization did not prove as successful as depressurization in the remediation of methane in the houses. The results are detailed in Appendix A-1. Some of the units displayed elevated methane concentrations above levels which were previously recorded in both pre-pumping and active-pumping phases. Elevated concentrations were recorded in units 71, 72, 49, 51 and 52. Although over time, methane concentrations in each of the above units declined, elevated concentrations were still persistent especially after a precipitation event such as on August 4. By monitoring adjacent housing units to housing block A, the migration of methane through the soil could be determined. For those housing units monitored in the vicinity of Block A, no housing unit displayed significantly elevated concentrations during the pressurization phase.

#### 4.2 Pressure

The installation of the slab and wall probes also facilitated the measurement of pressures across the concrete floors and walls. Extensive measurement of gas pressures was carried out in this field program.

The most frequent measurement of pressures involved the documentation of slab pressures as shown in Appendix A-6. Slab pressures were proportional in magnitude to the suction pressure in the gas extraction system. By increasing or decreasing the suction pressure, the pressure in the slab probes reacted accordingly. The slab pressures also had a degree of variation between the units. For example, in Block C, unit 48 showed significant depressurization due to pumping, however, the next house unit 49, showed relatively little depressurization. Such differences may be due to the differences in permeability and/or degree of connection between the sub-floor and perimeter venting system. Regardless of the differences, it does appear that the active venting systems as installed in the two blocks were able to cause at least some depressurization of the basement floors.

To determine the cause for the lack of depressurization in some of the units, additional permeability testing was conducted on the sub-floor space in several of the units in Blocks A and C. Permeability testing was conducted by drilling a 19 mm hole in the concrete floors of various units and connecting an industrial vacuum cleaner to these access ports. This testing took place while the active venting system was turned off. Of the units tested in Block C (ie. units 48, 49 and 52), all showed good depressurization across the basement floor (Appendix A-15). This was an important observation. Based on this observation and the results of the active depressurization described in the previous paragraph, it was concluded that although good permeability characteristics exist directly beneath the basement floors, in some cases a lack of connection between the sub-floor and the perimeter venting system exists. This is especially true of units 49 and 52 in Block C. Permeability testing of the sub-slab floor space in Block A indicated relatively good permeability with perhaps the exception of unit 71 (Appendix A-15). This confirms suspicions of poor permeability as stated in Section 3.4.

The wall probes which were installed indicated that depressurization was also achieved outside of the basement walls. As seen in Appendix A-7 and A-8, when the active soil ventilation system is in operation, a degree of depressurization was achieved in the wall probes on both Blocks A and C. In comparing the two different soil ventilation systems, it is apparent that, for most cases soil gas extraction wells provide more effective depressurization of the

basement floors than do the perimeter vents, whereas, the perimeter vents appear to cause more effective depressurization across the basement walls.

Another important result from the monitoring program, was that, when the soil gas extraction system was shut down, essentially no positive gradient was observed across the basement walls or floor. Both wall and floor probes were measured on several occasions, including spot measurements at night and after the rainfall events of May 2 and May 5. At no time were definitive positive pressures detected below or beside the basement floors and walls.

One soil probe was also monitored for pressure during the field testing. The gas pressure in monitor M70R was monitored; the results are shown in Appendix A-5. As seen in Appendix A-5, the gas pressure at M70R was an important factor for gas movement. If the gas pressure in M70R was positive, the concentration of methane at V71F was elevated. However, the pumping of the soil gas extraction wells can also control the nearby soil gas pressure, as seen in Appendix A-14. When pumping was initiated, the soil gas pressure immediately dropped indicating that the monitoring well was within the zone of influence.

Other influence tests were also conducted between the units of Block A. As seen in Appendix A-14, wells in the individual units primarily affected the depressurization within the unit where the soil gas extraction well was located. Based on the results observed, the zone of influence was generally quite limited.

#### 4.3 Carbon Monoxide

As stated previously, carbon monoxide may exist in the vicinity of old landfill sites. As such, carbon monoxide was monitored in ambient basement air as well as in some slab probes. The results of ambient air concentrations are shown in Appendix A-10. Essentially no carbon monoxide was detected in the ambient air or the exhaust vents. Slab probes were checked for carbon monoxide on April 28, May 1 and May 2. At no time did carbon monoxide concentration exceed 2 ppm. At one point, landfill gas was sampled in order to check if some CO was present. The Scott Alert S109 meter (which also measures oxygen and hydrogen sulfide) recorded 13% oxygen, 99 ppm hydrogen sulfide, however, 0 ppm

carbon monoxide was detected. Therefore, carbon monoxide was ruled out as a possible problem since it was essentially non-detectable.

#### 4.4 Carbon Dioxide

The carbon dioxide concentrations as measured at soil probe M70R and vent V71F are tabulated in Appendix A-5. Based on the results of the carbon dioxide levels in both the depressurization and pressurization activities, very little variation exists within the carbon dioxide concentrations at these locations. Similarly, the carbon dioxide to methane ratio for the riser stack at V71F was for the most part reasonably consistent. However, due to the varying methane concentrations at soil probe M70R, the  $CO_2/CH_4$  ratio varied from 0.25 to 9.0.

#### 4.5 Relative Humidity and Temperature

The relative humidity and temperature measurements conducted during this field program are summarized in Appendix A-5. Based on the limited measuring program, the relative humidity in the flue gases at V71F varied from 30% to 86% over a 17 day period. Over the same period, temperatures varied 6°C to 29°C. From the limited data set, the lowest relative humidity values recorded generally were related to the highest recorded temperature of the flue gases. In most cases, the flue gas temperature exceeded the daily high temperatures. (Appendix A-11). Flue gas temperatures sampled during the morning hours often were greater than the daily high. This would seem to suggest that gases being pumped by the ventilation system were gases which were already present in the subsurface.

Since the flue gases were normally higher in temperature than the outside ambient air and in some cases likely higher than the basement temperatures, the possibility of a gradient developing across the floor due to a temperature difference is possible.

#### 4.6 Volatile Organic Compounds

Air sampling was conducted on four different occasions, at several locations, and by different methods during the field

program. A chronological summary of the VOC air sampling program is detailed below.

---

Table 4  
SUMMARY OF VOC SAMPLING PROGRAM

<u>Date</u>	<u>Description of Sampling Procedure, Location</u>
April 16 (pre-pumping)	Instantaneous sample @ V71F, V56F, V49F Integrated sample of outdoor ambient air
May 24 (active-pumping)	Instantaneous sample @ V71F, V56F, V49F Integrated sample of outdoor ambient air.
April 25 (post-pumping)	Instantaneous sample @ V71F, V56F, V49F Integrated sample of outdoor ambient air
August 7 (active-pumping)	Instantaneous sample @ V46R Instantaneous sample of indoor basement ambient air in units 45, 49, 51

---

Two different sampling procedures were implemented during the field program, instantaneous and integrated sampling. Although the term instantaneous sampling implies that a sample is obtained instantaneously, a period of approximately 10 minutes was required to obtain an adequate sample. The integrated sample, on the other hand, was obtained through a metering valve restricting the sampling to a regulated flow rate. The integrated samples were obtained over the period of approximately one hour. Procedures for sampling are outlined in Sections 3.2 and 3.4.

Some of the samples taken during the program described above, had insufficient quantity for soil gas analysis. The instantaneous samples taken on April 6 had insufficient quantities according to Environment Canada. All other samples had sufficient quantities for analysis. The results of the vent gas analysis is presented on Table 5 and the comparative analysis of the ambient basement air to vent gases is shown in Table 6. The corresponding methane readings taken at the time of VOC sampling have been included on Tables 5 and 6.



Table 5  
SUMMARY OF VOLATILE ORGANIC COMPOUNDS ANALYSIS ( $\mu\text{g}/\text{m}^3$ )  
(Vent Pipe Samples)

Location Date Type of Sample	Outside April 6 Integrated	Outside April 25 Integrated	Outside May 24 Integrated	Block B April 25 Instantaneous	Block B May 24 Instantaneous	Block C April 24 Instantaneous	Block C May 24 Instantaneous	Block A April 25 Instantaneous	Block A May 24 Instantaneous	Ambient Air Quality Criterion
Freon 22	0.30	0.32	0.43	0.41	5.66	0.23	5.14	13.69	32.17	NA
Freon 12	1.53	2.03	1.90	264.6	0.72	4.07	2235.29	55.13	38.24	500,000
2-Methylpropane	0.73	0.46	1.55	1.90	8.43	0.12	36.13	3.51	7.93	NA
Freon 114	0.10	0.17	0.00	0.18	9.11	1.75	1.34	0.58	1.49	NA
Vinyl chloride	0	0.0	0.00	0.00	0.00	0.00	0.00	1.22	2.15	280
1-Butene	0.64	0.47	1.45	0.47	15.30	0.09	9.22	2.89	6.47	NA
1,3-Butadiene	0.13	0.57	1.62	0.51	7.15	1.15	8.81	0.13	6.38	22,000
Butane	1.81	1.33	4.62	4.12	29.12	0.25	12.83	4.23	9.09	NA
Trans-2-Butane	0.09	0.00	0.00	0.10	2.36	0.18	2.14	1.38	2.29	NA
2,2-Dimethylpropane	0.07	0.07	0.00	0.08	0.54	0.19	0.35	0.24	0.55	NA
1-Butyne	0.00	0.00	0.00	0.22	1.92	0.28	1.62	0.00	3.64	NA
cis-2-Butene	0.08	0.00	0.00	0.10	1.64	0.22	1.64	0.00	3.10	NA
2-methylbutane	1.36	1.05	4.45	2.87	721.0	168.23	16.16	3.59	7.41	NA
Freon 11	0.99	1.06	1.09	441.06	1.16	52.88	3.86	17.47	5.85	NA
1-Pentene	0.00	0.0	0.00	0.00	0.83	0.00	0.00	0.15	0.00	NA
Pentane	0.86	0.54	2.72	2.04	599.5	105.17	24.24	2.98	6.81	NA
1,1-Dichloroethylene	0.00	0.00	0.00	0.00	0.00	0.0	0.80	0.16	0.00	NA
Dichloromethane	12.00	0.40	6.85	2.14	1.05	0.33	2.91	0.99	1.90	NA
Freon 113	497.88	0.00	517.99	0.95	1.37	0.54	1.23	0.00	0.00	NA
2,2-Dimethylbutane	0.00	0.00	0.00	0.09	105.70	28.82	1.52	0.17	0.00	NA
trans-1,2-Dichloroethane	0.00	0.00	0.00	0.00	0.00	0.00	0.00	0.00	0.00	NA
cyclopentane	0.22	0.09	0.49	0.30	58.20	10.77	1.97	0.98	2.09	NA
1,1-Dichloroethane	0.00	0.00	0.00	0.00	1.43	0.32	0.00	6.20	10.31	NA
2,3-Dimethylbutane	0.12	0.07	0.33	0.18	520.50	71.11	9.45	0.26	0.55	NA
2-methylpentane	1.13	0.86	1.50	1.11	709.0	216.65	14.71	1.75	2.37	NA
3-methylpentane	0.44	0.31	1.12	0.63	763.5	210.58	15.58	0.87	2.26	NA
1-Hexene	0.00	2.69	0.00	0.48	683.0	187.80	17.17	7.92	0.00	NA
Bromochloromethane	0.00	0.00	0.00	0.00	0.00	0.00	0.00	0.00	0.00	NA
Hexane	0.53	0.32	1.23	0.85	318.60	136.62	14.03	1.19	3.08	12,000
Chloroform	0.12	0.00	0.00	0.09	0.00	0.57	0.00	0.40	0.71	500
Methyl cyclopentane	0.13	0.10	0.31	0.22	293.9	148.65	4.59	0.63	2.17	NA
1,2-Dichloroethane	0.16	0.15	0.60	0.17	2.11	0.86	0.00	0.50	1.02	NA
1,1,1-Trichloroethane	1.27	0.64	2.16	6.37	1.30	0.98	4.58	1.06	2.65	115,000
Benzene	0.73	0.65	1.61	0.88	2.83	0.66	1.71	3.99	4.92	3,300

Table 5  
(Continued)

Location Date Type of Sample	Outside April 6 Integrated	Outside April 25 Integrated	Outside May 24 Integrated	Block B April 25 Instantaneous	Block B May 24 Instantaneous	Block C April 24 Instantaneous	Block C May 24 Instantaneous	Block A April 25 Instantaneous	Block May 24 Instantaneous	Ambient Air Quality Criterion
Carbon tetrachloride	0.70	0.67	1.15	0.82	1.21	0.61	1.45	0.75	1.11	600
Cyclohexane	0.08	0.09	0.00	0.48	94.15	55.45	3.25	0.86	3.40	100,000
2-methylhexane	0.85	0.24	0.57	0.55	622.50	509.95	7.86	0.27	1.00	NA
2,3-Dimethyl pentane	0.10	0.11	0.00	0.17	426.15	229.28	6.72	0.46	0.00	NA
3-methylhexane	0.31	0.66	0.50	0.51	888.50	653.88	10.44	1.47	0.78	NA
1,2-Dichloropropane	0.22	0.17	0.00	0.00	6.06	0.14	0.00	0.00	0.91	NA
Dibromomethane	0.45	0.00	0.00	0.00	0.00	0.28	0.00	0.00	0.00	NA
Bromodichloromethane	0.30	0.15	0.62	0.11	66.35	80.56	1.65	0.21	0.88	NA
Trichloroethylene	0.16	0.00	0.30	0.13	0.00	0.00	0.00	0.00	0.00	280,000
2,2,4-Trimethylpentane	0.17	0.04	0.43	0.36	34.12	24.97	2.33	0.07	0.75	NA
Heptane	0.17	0.14	0.38	0.49	120.05	54.68	2.13	0.32	0.55	NA
cis-1,3-Dichloropropene	0.45	0.00	0.00	0.00	0.00	0.42	0.00	0.00	0.00	NA
Methylcyclohexane	0.82	0.22	0.87	0.51	362.40	231.36	8.28	0.75	0.83	NA
2,5-Dimethylhexane	0.00	0.00	0.00	0.00	22.40	16.40	1.38	0.08	0.00	NA
trans-1,3-Dichloropropene	0.00	0.00	0.00	0.00	0.00	0.00	0.00	0.00	0.00	NA
1,1,2-Trichloroethane	0.21	0.00	0.00	0.00	15.19	6.42	0.00	0.00	0.00	NA
2,3,4-Trimethylpentane	0.14	0.00	0.00	0.11	10.42	0.15	1.41	0.15	0.00	NA
Toluene	1.17	1.48	4.23	9.57	18.50	10.24	117.06	10.24	7.66	2,000
3-methylheptane	0.08	0.12	0.00	0.15	83.05	0.11	1.50	0.11	0.61	NA
Dibromochloromethane	0.25	0.00	0.00	0.00	0.00	0.00	0.00	0.00	0.00	NA
2,2,5-Trimethylpentane	0.06	0.12	0.00	0.06	4.81	0.07	0.39	0.07	0.00	NA
EDB	0.30	0.00	0.00	0.00	0.00	0.00	0.00	0.00	0.00	NA
Octane	0.24	0.09	0.00	0.24	8.66	0.16	0.65	0.16	1.79	NA
Tetrachloroethylene	0.41	0.15	0.00	0.46	1.29	0.43	1.67	0.43	1.16	NA
Chlorobenzene	0.19	0.00	0.00	0.21	9.38	0.00	0.33	0.00	0.00	NA
Ethyl benzene	0.41	0.29	1.15	1.04	40.64	0.67	43.61	0.67	1.81	4,000
m&p-Xylene	0.93	0.55	2.46	1.67	6.70	1.56	89.37	1.56	2.88	NA
Nonane	0.33	0.16	1.05	0.53	2.54	0.22	1.83	0.22	1.09	NA
iso-propylbenzene	0.32	0.07	0.28	0.16	7.63	0.08	4.98	0.08	0.48	100
n-propylbenzene	0.44	0.06	0.27	0.16	7.57	0.12	3.69	0.12	0.31	NA
3-ethyltoluene	0.53	0.12	0.56	0.36	5.11	0.30	4.17	0.30	0.59	NA
4-ethyltoluene	0.74	0.05	0.32	0.17	2.36	0.14	1.56	0.14	0.32	NA
1,3,5-trimethylbenzene	0.45	0.06	0.38	0.16	0.95	0.16	1.33	0.16	0.38	NA
2-ethyltoluene	0.51	0.05	0.29	0.15	1.53	0.13	1.17	0.13	0.30	NA

Table 5  
(Continued)

Location Date Type of Sample	Outside April 6 Integrated	Outside April 25 Integrated	Outside May 24 Integrated	Block B April 25 Instantaneous	Block B May 24 Instantaneous	Block C April 24 Instantaneous	Block C May 24 Instantaneous	Block A April 25 Instantaneous	Block A May 24 Instantaneous	Ambient Air Quality Criterion
1,2,4-trimethyl benzene	1.36	0.24	1.10	0.57	3.05	0.77	4.50	0.77	1.18	35
n-decane	0.94	0.24	0.00	0.20	5.89	1.82	0.96	1.82	10.67	NA
1,3-dichlorobenzene	1.15	0.00	0.00	0.00	0.00	0.00	0.00	0.00	0.00	NA
iso-Butylbenzene	0.53	0.06	0.65	0.14	0.96	0.13	0.34	0.13	1.25	NA
Butylbenzene	0.47	0.23	0.60	0.53	19.75	0.75	8.64	0.75	2.32	NA
1,4-Dichlorobenzene	0.38	0.05	0.45	0.21	1.79	0.07	1.25	0.07	0.61	NA
p-cymene	0.81	0.08	0.43	0.06	8.43	0.12	5.81	0.12	0.51	NA
1,2,-Dichlorobenzene	1.47	0.00	0.00	0.00	0.00	0.00	0.00	0.00	0.00	NA
1,3-Diethylbenzene	1.94	0.00	0.50	0.14	1.13	0.11	1.07	0.11	0.00	NA
1,4-Diethylbenzene	2.33	0.00	0.72	0.22	1.53	0.23	2.00	0.23	0.00	NA
1,2-Diethylbenzene	0.99	0.00	0.00	0.07	0.54	0.08	0.77	0.08	0.00	NA
Bromoform	0.40	0.00	0.00	0.00	0.00	0.00	0.00	0.00	0.00	NA
Styrene	0.54	0.21	0.00	1.86	359.85	0.79	150.06	0.79	3.48	400
1,4-Dichlorobutane	0.00	0.00	0.00	0.00	0.00	0.00	0.00	0.00	0.00	NA
o-Xylene	0.41	0.22	0.89	0.63	3.63	0.59	23.68	0.59	1.08	2,300
methane (ppm)	-	-	-	3150	-	95	24	6000	15500	NA

Notes: NA indicates criteria is not available

Source: Criterion based on: Proposed Air Quality Standards, Discussion Paper  
Air Pollution - General Regulation (Regulation 308),  
Ontario Ministry of the Environment, November 1987.

Samples taken from Block A were taken at V71F;  
Samples taken from Block B were taken at V56F.  
Samples taken from Block C were taken at V49F.

Methane sampling conducted with OVA onsite

Table 6  
 SUMMARY OF VOLATILE ORGANIC COMPOUNDS ANALYSIS ( $\mu\text{g}/\text{m}^3$ )  
 (Basement Air - Vent Comparison)

Location Date <u>Type of Sample</u>	Unit #51 Ambient <u>Basement Air</u>	Unit #49 Ambient <u>Basement Air</u>	Unit #45 Ambient <u>Basement Air</u>	Vent 46R <u>Exhaust Gas</u>	Ambient Air Quality <u>Criterion</u>
Freon 22	0.31	0.40	0.36	0.37	NA
Freon 12	11.71	16.64	8.59	0.62	500,000
2-Methylpropane	0.73	2.58	0.57	0.37	NA
Freon 114	0.21	0.57	0.21	0.14	NA
Vinyl chloride	0.00	0.00	0.00	0.00	280
1-Butene	0.53	0.83	0.50	0.23	NA
1,3-Butadiene	0.51	0.93	0.58	2.14	22,000
Butane	1.00	1.36	1.56	0.29	NA
Trans-2-Butane	0.00	0.13	0.00	0.55	NA
2,2-Dimethylpropane	0.12	0.08	0.07	0.07	NA
1-Butyne	0.00	0.00	0.00	0.63	NA
cis-2-Butene	0.00	0.00	0.00	0.45	NA
2-methylbutane	1.55	3.36	1.53	4.51	NA
Freon 11	5.36	6.30	2.03	3.16	NA
1-Pentene	0.00	0.00	0.00	0.00	NA
Pentane	1.05	3.26	1.00	5.31	NA
1,1-Dichloroethylene	0.00	0.12	0.00	0.13	NA
Dichloromethane	2.25	8.37	1.39	2.55	NA
Freon 113	1.11	1.06	0.81	1.06	NA
2,2-Dimethylbutane	0.00	0.13	0.00	0.46	NA
trans-1,2-Dichloroethane	0.00	0.00	0.00	0.00	NA
cyclopentane	0.12	0.23	0.11	0.24	NA
1,1-Dichloroethane	0.00	0.00	0.00	0.00	NA
2,3-Dimethylbutane	0.10	0.19	0.11	2.62	NA
2-methylpentane	1.41	2.32	1.22	4.30	NA
3-methylpentane	0.48	1.04	0.50	4.79	NA
1-Hexene	0.00	0.00	0.00	4.18	NA
Bromochloromethane	0.00	0.00	0.00	0.00	NA
Hexane	0.45	1.30	0.57	3.42	12,000
Chloroform	0.00	0.26	0.13	1.29	500
Methyl cyclopentane	0.14	0.32	0.14	0.12	NA
1,2-Dichloroethane	0.15	0.00	0.14	0.22	NA
1,1,1-Trichloroethane	0.93	56.61	0.92	0.74	115,000

Table 6  
(Continued)

Location Date <u>Type of Sample</u>	Unit #51 Ambient <u>Basement Air</u>	Unit #49 Ambient <u>Basement Air</u>	Unit #45 Ambient <u>Basement Air</u>	Vent 46R <u>Exhaust Gas</u>	Ambient Air Quality <u>Criterion</u>
Benzene	0.77	1.38	0.83	0.07	3,300
Carbon tetrachloride	0.78	0.84	0.77	0.88	600
Cyclohexane	0.12	0.80	0.20	0.86	100,000
2-methylhexane	0.77	0.74	0.36	0.52	NA
2,3-Dimethyl pentane	0.25	0.18	0.00	0.23	NA
3-methylhexane	0.67	0.67	0.53	0.98	NA
1,2-Dichloropropane	0.28	0.38	0.24	0.20	NA
Dibromomethane	0.35	0.00	0.00	0.24	NA
Bromodichloromethane	0.34	0.36	0.28	0.47	NA
Trichloroethylene	0.42	0.42	0.26	0.16	280,000
2,2,4-Trimethylpentane	0.21	0.39	0.21	0.54	NA
Heptane	0.16	1.61	0.20	0.12	NA
cis-1,3-Dichloropropene	0.00	0.00	0.00	0.00	NA
Methylcyclohexane	0.18	0.76	0.23	1.82	NA
2,5-Dimethylhexane	0.00	0.00	0.00	0.00	NA
trans-1,3-Dichloropropene	0.00	0.00	0.00	0.00	NA
1,1,2-Trichloroethane	0.00	0.23	0.25	0.26	NA
2,3,4-Trimethylpentane	0.00	0.18	0.00	0.25	NA
Toluene	2.28	56.34	3.03	0.43	2,000
3-methylheptane	1.44	0.23	2.29	0.18	NA
Dibromochloromethane	0.27	0.00	0.19	0.15	NA
2,2,5-Trimethylpentane	0.54	0.15	0.87	0.06	NA
EDB	0.29	0.00	0.20	0.20	NA
Octane	0.00	0.63	0.10	0.00	NA
Tetrachloroethylene	0.00	0.58	0.00	0.00	NA
Chlorobenzene	0.21	0.14	0.05	0.05	NA
Tethyl benzene	0.32	2.30	0.30	0.14	4,000
m&p-Xylene	0.74	7.43	0.25	0.72	NA
Nonane	0.27	1.15	0.28	0.07	NA
iso-propylbenzene	0.08	0.23	0.23	0.28	100
n-propylbenzene	0.08	0.33	0.08	0.00	NA
3-ethyltoluene	0.16	0.84	0.07	0.04	NA
4-ethyltoluene	0.15	0.50	0.17	0.00	NA
1,3,5-trimethylbenzene	0.12	0.54	0.20	0.09	NA

Table 6  
(Continued)

<u>Location Date Type of Sample</u>	<u>Unit #51 Ambient Basement Air</u>	<u>Unit #49 Ambient: Basement Air</u>	<u>Unit #45 Ambient Basement Air</u>	<u>Vent 46R Exhaust Gas</u>	<u>Ambient Air Quality Criterion</u>
2-ethyltoluene	0.07	0.38	0.14	0.00	NA
1,2,4-trimethyl benzene	0.34	1.72	0.09	0.00	35
n-decane	0.15	2.24	0.46	0.14	NA
1,3-dichlorobenzene	0.00	0.00	0.24	0.00	NA
iso-Butylbenzene	1.97	0.05	0.00	0.13	NA
1,4-Dichlorobenzene	0.14	0.39	3.65	0.14	NA
cymene	0.09	0.20	1.89	0.10	NA
1,2-Dichlorobenzene	0.00	0.00	0.12	0.00	NA
1,3-Diethylbenzene	0.08	0.06	0.00	0.00	NA
1,4-Diethylbenzene	0.08	0.22	0.11	0.00	NA
1,2-Diethylbenzene	0.00	0.15	0.09	0.00	NA
Bromoform	0.00	0.00	0.00	0.00	NA
Styrene	0.21	0.92	0.13	0.18	400
o-Xylene	0.25	2.19	0.29	0.17	2,300
methane (ppm)	2.5	2.5	2.5	90	NA

Notes: NA indicates criteria is not available

Source: Criterion based on: Proposed Air Quality Standards, Discussion Paper  
Air Pollution - General Regulation (Regulation 308)  
Ontario Ministry of the Environment, November 1987.

Samples were taken on August 7, 1989 at 12:00

On Tables 5 and 6, all measured concentrations are compared to time-weighted average values as proposed by the Ontario Ministry of the Environment. Several key parameters which may be found in municipal refuse such as benzene, toluene, xylene, and vinyl chloride, all had maximum concentrations far below their respective criterion. No measured concentrations exceeded the government criteria.





## 5.0 DISCUSSION OF RESULTS

### 5.1 Overview of Baseline Methane Concentrations

The baseline methane concentrations, as observed in the candidate units in this study, were within the ranges previously identified by earlier studies (e.g. Morrison Beatty Ltd., 1986). Morrison Beatty Ltd. (1986) grouped the results according to several categories:

- 1) No detectable or significant methane occurrence. All measurements in this grouping were less than 30 ppm.
- 2) Minor but frequent occurrence of methane. Frequent concentrations up to 50 ppm were recorded.
- 3) Confirmed methane occurrence well below hazardous levels. Repeated results contained methane but, were at all times less than 20% LEL.
- 4) Confirmed methane occurrence where findings of gas with at least one measurement greater than 20% LEL.

According to the Morrison Beatty summary, the candidate townhouses used in this study were grouped in the following manner as shown on Table 7. The concentrations as obtained in this study from the pre-pumping work phase, are also displayed on Table 7 for comparison.

---

Table 7  
SUMMARY OF GROUPINGS ACCORDING TO DETECTABLE  
METHANE IN BASEMENTS OF TOWNHOUSES

	Morrison Beatty	CANVIRO
Category 1:	Units 44, 45, 46, 47, 49, 50, 53, 56	Units 44, 45, 46, 47, 49, 50, 51, 52, 53, 54, 56
Category 2:	Units 48, 73	Units 48
Category 3:	Units 51, 54, 74	Units 55, 72, 73, 74
Category 4:	Units 52, 71, 72	Unit 71

---

In general, the findings of both the studies were quite comparable. The exceptions included units 51, 52, 54, 55, 72 and 73. Of these units, no data was available from the Morrison Beatty study for unit 55. There are several possible reasons for the discrepancies between these studies.

Due to the moist soil conditions discovered along the rear of Block C (refer to Appendix A-13), migration of methane from nearby refuse can be expected to be minimized. Therefore, a reduction in methane concentrations in units 51, 52 and possibly 54 is realizable. Despite the differences noted between units 72 and 73, the values are definitely within the same ranges. Some of the differences mentioned above may also be related to the method of sampling. The method used by Morrison Beatty identified "hot spots" and characterized the units accordingly; this study measured values by an average basement concentration.

Some of the soil probes used in this study and reported on by Morrison-Beatty were also comparable.

Probe #	Morrison-Beatty (1986)		CANVIRO	
	Pressure (Pa)	Concentration	Pressure (Pa)	Concentration
M70R	(-87) - (+79)	44 - 100% GAS	(-67) - (+104)	80% LEL - 71% GAS
C (unit 45)	(- 2) - (+ 6)	0 - 63 ppm	(0)	3 - 8 ppm
M53S	(- 2) - (+ 2)	22 - 70% GAS	not available	38 - 59% GAS

The pressure and concentration values obtained at M70R in this study were influenced by the soil ventilation at the high block as noted in Section 4.2. Therefore, pressures and concentrations are likely to be lower during this study period. Concentrations may also be lower in unit 45 slab probe C due to wet soil conditions, as mentioned previously.

In general, the methane concentrations as obtained in this study indicated that major problems do not exist in most of the townhouse units. With exception of units 48, 55, 71, 72, 73 and 74, all concentrations in the study units remained below 30 ppm, thereby, containing negligible methane.

It should be noted that the above groupings are somewhat arbitrary and do not necessarily reflect safe or even regulatory standards for confined spaces. Although presently no

standard exists for Ontario, a proposed standard of 100 ppm has been suggested in the United States for a methane concentration in a confined space. Perhaps a more appropriate guideline applicable to this study may be 100 ppm.

## 5.2 Effects of Active Soil Ventilation (Depressurization)

Based on the results of active pumping phase, the soil ventilation system had varying effects on each of the different housing blocks.

### Block C

A program for testing the effectiveness of the soil ventilation system on Block C was faced with several problems:

- The initial concentrations of methane in the basements was quite low in the pre-pumping phase. Therefore, any improvement to these values would be difficult to substantiate due to normal fluctuations.
- During the active pumping program of Block C, no major rainfall events occurred. Only two smaller rainfall events of 7.4 mm and 9.4 mm occurred on April 14 and April 29 respectively. A rainfall event of 20 mm or more would constitute a major rainfall event. Major rainfall events can cause effective gas compression thereby, raising methane levels in the homes.

One possible reason for the initial low methane concentrations may have been due to the high moisture content detected in the surrounding soils. Due to the suspected high moisture content, methane migration may have been limited and therefore, only low methane levels were measured. Several lines of evidence seem to suggest a high moisture content existed in the surrounding soils.

- The soil excavation conducted at the rear of Block C revealed very moist soils.
- The permeability tests developed large suction pressures at riser pipe V44R, V49R and V52R. Even with the damper in a fully closed position (at V46R), a pressure of -115 Pa (Appendix A-14) was

developed at V52R. This lack of pressure drop indicates low permeable soils.

- When the system was put in operation, some of the slab probes (units 52, 50, 46) adjacent to the rear wall exhibited rather low slab depressurization. This occurred despite large suction potential only one to two metres away.

Even with the low initial methane concentrations, the active soil ventilation process did little to suppress the detected levels. Since essentially no distinctive change in methane concentrations was evident from the pre-pumping to active-pumping phases, it may be concluded that the active perimeter venting system has limited value. The poor performance experienced at Block C may have been partially due to the low permeability connections which exist between the perimeter vent pipe and sub-slab floor space (as discussed in Section 4.2).

Despite the poor performance discussed above, the perimeter vent as a passive system still had some effect on minimized subsurface soil gases. As described in Section 4.1, significant methane concentrations were identified in unit 48 after the riser caps were capped. However by reconnecting the stacks, the concentration again declined. Providing that the venting system is not clogged, soil gas concentrations may be reduced.

Based on the results of the field exercises and the discussion above, the following conclusions were reached:

- The soil ventilation system presently existing around the footings of Block C does effectively reduce methane concentration in the basement ambient air, with or without a fan connected.
- The poor connection between the venting system and the sub-floor gravel layer as well as the moisture content in the soil could minimize the potential of an active or passive soil ventilation system.
- Based on the depressurization values obtained, the ventilation system causes better depressurization around the walls as compared to beneath the floors. Such a system would be effective for collecting methane which moves laterally in the soil,

however, its effectiveness may be limited for methane moving upward through the basement floors.

- The perimeter vent pipe system as installed at the Strasburg Road Townhouses is prone to silt infilling. Blockages may cause parts of the system to be ineffective.

### Block A

The evaluation of the soil ventilation system on Block A was much more definitive for the following reasons:

- Higher initial concentrations were recorded during the pre-pumping phase. Therefore, effectiveness was easier to determine.
- Several significant precipitation events occurred during the testing period.

As outlined in Section 4.1, the active venting system was responsible for reducing the methane levels in all of the housing units of Block A. Providing that sufficient depressurization was implemented, methane levels in the ambient basement air were reduced by as much as 99.9 percent of their initial pre-pumping concentration levels.

The largest improvements were noted in unit 71 of Block A where initially the highest methane readings were recorded. In view of the high historical values recorded, this unit was used to determine a minimum operating criteria for the effective reduction of methane. As detailed in previous sections of this report, only one soil gas extraction well was initially installed in unit 71. Although significant decreases in methane were realized, a distinct lack of depressurization was also noted (Figure 6). With minimal depressurization in some sections of the floor, stack effects especially during the night could cause a gradient reversal causing a methane buildup inside the basement. By realizing the possible concentrations that may exist beneath the basement floor slab (such as in Figure 10), minimal depressurization is not advisable.

With the installation of an additional soil gas extraction well, a more effective depressurization was achieved. With two soil gas extraction wells in operation, an effective depressurization of 15 Pa at the mid-floor location was sufficient to provide satisfactory results.

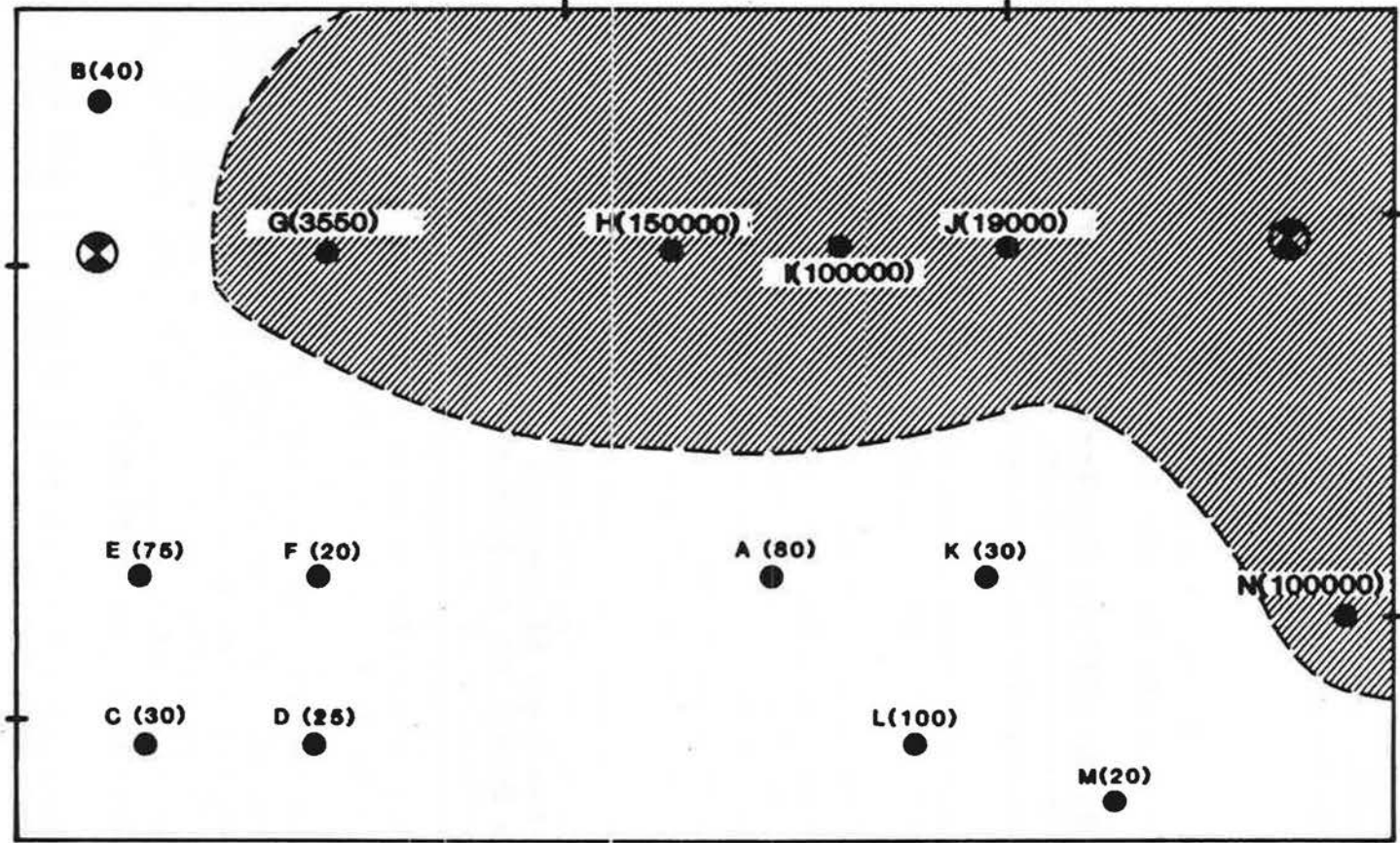

● CONCENTRATIONS ARE ALL IN ppm

**LEGEND:**

▨ - ZONE OF MAJOR CONTAMINATION

**FIGURE 10: UNIT #71 SHOWING ZONE OF MAJOR SUB-SLAB CONTAMINATION (on may 2, 1989)**

Although in general active soil ventilation processes were effective in reducing methane, one cautionary note should be made. On the occasion of fan failure during a storm event, excessive methane levels may still be experienced. In order to address this concern, additional technical solutions could include: a safety power supply, excavation of refuse, or both of the above.

In summary, the results of the field program on Block A indicate:

- The system of interior wells is effective in reducing ambient basement methane concentrations.
- Fan failure scenarios indicate that a failure in adverse environmental conditions could cause excessive concentrations to exist. In order to meet possible regulatory guidelines, the solution should include additional remedial action.

### 5.3 Effects of Active Soil Ventilation (Pressurization)

As noted in Section 4.1, the pressurization of sub-slab soil gases did not prove to effectively remediate methane migration into basements. Possible reasons for the lack of success are two-fold:

- low permeability soils existing adjacent to the houses
- an active methane producing environment exists under some basement floors

In previous testing with the depressurization concept, there were several indications that the adjacent soils to the basement walls had effectively low gas permeabilities. During the pressurization testing, similar effects were realized. Despite the pressurization of Block A, no significant concentration increases were noted in the adjacent monitored units. Therefore for any soil gas existing beneath the basement floors, the pathway of least resistance for these gases would be through the basement envelope.

If an active methane producing environment did not exist beneath the basement floors, it would be expected that the

soil gases entering the basements would improve over time. If however an active methane producing environment (ie. refuse buried beneath the floor) did exist, it would be virtually impossible to suppress methane levels. As documented in several housing units, this effect was realized.

Although the above reasons are conjectured, it was evident from a limited experimental effort that pressurization was not a feasible remedial solution for this site.

#### 5.4 Volatile Organic Compounds

##### Outside Ambient Air

The results of the organic analyses indicated that the outside ambient air contained only one organic compound at significant concentrations, ie. 1,2,3-trichloro-1,2,2-trifluorane (Freon 113). The occurrence of the compound was nevertheless sporadic throughout the sampling program. On April 6 and on May 25 in the pre-pumping and post-pumping phases of the project, elevated levels of Freon 113 were recorded. However, on April 25 when active pumping was taking place, no Freon 113 was detected in the outside integrated sample. This evidence seems to suggest that the Freon 113 was not related to the stack emissions from the vent pipes. Also in view of the absence of other contaminants found in the vent stack samples, it does not appear that the outside ambient air is being significantly degraded.

##### Vent Pipes

As for the organic analyses of the vent pipe gases of the candidate housing blocks, other organic compounds with elevated concentrations were detected. However, with the detection of these various compounds, differences in the type and concentration were found to exist at the various candidate housing blocks.

Of the candidate housing blocks, Block A had some of the highest recorded methane concentrations but also some of the lowest concentrations of organic compounds. During the pumping phase on April 25, slightly elevated concentrations of Freon 22, Freon 12, Freon 11 and toluene were detected in the vent V71F. Later in the post-pumping phase on May 24, slightly elevated concentrations of Freon 22, Freon 12, and



n-decane were analyzed. Of these elevated compounds, none of the concentrations exceeded ambient air quality criteria and in most cases were several orders of magnitude below the standard.

The vent pipe at the control block (Block B) had lower methane concentrations but a greater quantity of elevated organic compounds. On the April 25 sampling date, Freon 12 and Freon 11 were detected at elevated concentrations. On the successive sampling date, increases in many of the other analyzed compounds were realized, e.g. butane, 21-methylbutane, 2-methyl pentane, 3-methyl hexane, methyl cyclohexane, styrene, etc. Although all of these concentrations were below the provincial criteria, styrene was close to the standard. This is not entirely unexpected since the vent pipe that was sampled did not have an induced flow at the time of sampling. Therefore gases could have built up over time. Furthermore, the styrene compound which was detected may have been due to the ABS vent pipe. Styrene is used in the manufacture of ABS plastics.

The housing Block C, also registered greater concentrations of organic compounds as compared to Block A. A series of compounds detected in the April 25 sampling event included: 2-methyl butane, Freon 11, pentane, several methylpentane isomers, hexane, methyl hexane isomers, etc. After two weeks of the active-pumping phase, a noticeable decline occurred. On May 24, Freon 12, toluene and styrene existed as the only elevated compounds. Although this may imply a decrease in organic compounds over extended periods of pumping, the sampling period and frequency of sampling was not sufficiently long to be conclusive. Despite the elevated concentrations which were detected, at no time were the concentrations higher than the provincial criteria for ambient air quality.

#### Basement Ambient Air

The final sampling event on August 7 was aimed at establishing a possible relationship between the ambient basement air of some of the units with the discharge vent gases. As seen in Table 6, however, very few compounds were detected at significantly elevated concentrations making the task of fingerprinting difficult. Units 51 and 45 had only slightly elevated concentrations of Freon 12 whereas the sample from Unit 49 had elevated concentrations of Freon 12, 1,1,1-trichloromethane, and toluene. On the other hand, the elevated compounds in the vent gases included only small

quantities of pentane and methyl pentane isomers. It is apparent from vent and basement air analyses (on Table 6) that comparative fingerprinting cannot be conclusive.

Despite the lack of a positive comparison above, some other observations were evident. Based on earlier findings during the testing of the depressurization and pressurization schemes, several difficulties were encountered. During the depressurization trials, Unit 49 had very poor depressurization, Unit 51 had moderately poor depressurization and Unit 45 had good depressurization. The difference in the degree of pressurization was due to the low conductivity characteristics between the sub-slab gravel layer and the perimeter venting pipe. Later when the sub-slab space was pressurized, the ambient air quality in Units 49 and 51 retained relatively high methane levels. It was concluded therefore that a source of methane likely existed beneath the basement floor. Therefore on August 7 with the depressurization system activated, the poor depressurization in Unit 49 was not sufficient to eliminate all basement gases. As a result, elevated concentrations of Freon 12, 1,1,1-trichloroethane, and toluene were likely present due to a nearby source of municipal refuse. On the other hand, the depressurization in Unit 51 may have been adequate to remove any elevated levels of organics.

Despite the above discussion of the presence of municipal refuse, it is also very apparent that the concentrations of organics at this site is extremely low. At all times, the concentrations did not exceed provincial criteria. As such, it can be presently concluded that volatile organic compounds are not deemed to be a problem at this site.

## 5.5 System Analysis

Methane which is generated from refuse will be transmitted through soil by means of advective or diffusive processes. Advective transport is dependent on a difference in pressure potential, whereas diffusive transport is propagated by concentration gradients. The travel times of methane will be enhanced in soils of low resistance or high permeability. Therefore, if basement structures are close to or are adjacent to zones of high permeability, chances for methane migration are strongly increased. On the contrary, zones of low permeability such as moisture laden soils effectively minimize methane migration.

Several mechanisms can enhance methane migration from source areas toward basement structures. Precipitation events, wind effects, and temperature gradients, stack effects, sub-surface hydraulic activity, barometric pressure, and pumping activity of a venting system may all contribute to increased or decreased basement methane concentrations. In the case of the Strasburg Townhouses, it is evident that many of the above mechanisms have contributed and enhanced the local methane migration at the site.

Once methane has collected underneath the basement floors, entry into the basement may take place either through advection through cracks or pore spaces or simply by diffusion. In order to restrict methane entry into basements, this study has shown that if sufficient negative pressures are developed across the basement floors, upward movement of methane can be minimized. In unit 71, a minimum depressurization of -15 Pa at mid-floor was necessary to achieve such results. Since this value is a good guideline in view of the high concentrations encountered at this location, a similar depressurization in other units should be of equivalent magnitude to achieve satisfactory results.

This minimum depressurization of -15 Pa should also not merely be restricted to a mid-floor location. This minimum value should be applied to all locations across the basement floor. In this manner, zones of low depressurization will not be allowed to be developed thereby restricting possible pathways of methane entry.

In order to achieve this minimum depressurization, the system of interior soil gas extraction wells offer the best potential. In view of low permeability zones which exist between the sub-floor granular layer and the existing perimeter vents in many of the housing units, the perimeter active venting system as installed on block C is not appropriate for the Strasburg Road townhouses.



## 6.0 CONCLUSIONS

The objectives of this study as outlined in Section 1.2 were aimed at determining the feasibility of active soil gas ventilation as a remedial measure for methane entry into basements. Based on the results and discussion in previous sections of this report, the conclusions are summarized below:

1. Active soil gas ventilation in a depressurization mode is an effective remedial measure for reducing methane entry into housing structures. During the course of this investigation, concentrations of methane were reduced by as much as 99.9 percent from the previously recorded concentrations.
2. Active soil ventilation in a pressurization mode did not prove effective in reducing methane entry into the housing structures. It was postulated that poor soil conductivity adjacent to the homes as well as buried refuse beneath basement floors may have contributed to the system ineffectiveness.
3. In the Strasburg Road Townhouses, a system of individual soil gas extraction wells was more effective in the reduction of methane than a perimeter soil gas extraction system which was also implemented. Due to a poor connection between the sub-floor gravel layer and perimeter vent pipe, effective remediation was not always possible with our implemented perimeter system.
4. Based on the analysis of a unit with the highest initial methane concentrations, a depressurization of 15 Pa was sufficient to reduce ambient basement methane levels to less than 15 ppm. A value of -15 Pa is therefore recommended as an effective operating sub-floor pressure in an active soil gas ventilation system.
5. In the event of a power or mechanical fan failure during a precipitation event, elevated methane concentrations may still be realized. Therefore, if an active soil gas ventilation system is eventually implemented, additional remedial measures should be implemented.

6. Air samples taken from exhaust pipes in the basement ambient air were analyzed for volatile organic compounds. Generally low concentrations were recorded; no parameters exceeded proposed provincial ambient air quality criteria. As such, air emissions with regard to VOCs are not viewed with concern.
7. Carbon monoxide which may also be present at older landfill sites was not detected in significant quantities. As such, carbon monoxide was not viewed with concern.

## 7.0

## REFERENCES

Morrison Beatty Limited, 1986. Landfill Gas Migration and Impact Assessment 400-440 Strasburg Road, Kitchener, report prepared for Dominion Soil Investigation, Inc.

Morrison Beatty Limited, 1987. Landfill Gas Control - Feasibility Study - 400-440 Strasburg Road, Kitchener, report prepared for Canada Mortgage and Housing Corporation.

Arthur Scott and Associates, 1988. Kitchener Townhouse Study Design Phase, preliminary discussion paper prepared for Canada Mortgage and Housing Corporation.

