



DEVELOPMENT AND VALIDATION OF A VERSATILE METHOD FOR THE CALCULATION OF HEAT TRANSFER IN WATER-BASED RADIANT SYSTEMS

Massimiliano Scarpa^{1,3}, Karl Grau², Bjarne W. Olesen³

¹ Department of Applied Physics, University of Padua, Padua, Italy

² Danish Building Research Institute, Aalborg University, Hørsholm, Denmark

³ International Centre for Indoor Environment and Energy, Technical University of Denmark, Lyngby, Denmark

ABSTRACT

The description of the thermal behaviour of radiant systems is complex due to the 3D heat transfer and the relevant thermal inertia characterising the active surface. As a consequence, it is necessary to define modelling simplifications in order to achieve a reliable forecast of the thermal field inside the structure and, hence, of the heat exchange between the active structure and the room.

This paper presents the whole process performed within the development of a calculation module integrated within software BSim (www.bsim.dk, by the Danish Building Research Institute) for the description of radiant systems. The present work started with the examination of existing calculation models for radiant systems. Then a model with further extensions was implemented and tested. Such a module is able to cover a wide range of cases with just one calculation tool. In the end, it was tested against field measurements in a climatic chamber at the Danish Technical University, Lyngby (Copenhagen).

INTRODUCTION

The calculation module starts from the simplification of the thermal field taking place in the active surface. As a matter of fact, that is strictly 3D due to the presence of pipes embedded in the slab and the water temperature variation along the circuit. Hence, the following simplifications were decided:

- The interaction between the pipe and the building structure is calculated through the definition of a thermal resistance that connects the external pipe surface with the pipe level, i.e. the fictitious plane where pipes are assumed to lie. In a few words, pipes are assumed to act as a thin active layer placed at the level where the axes of the pipes lie. There, pipes perform their own action, filtered by a thermal resistance, that resumes the uneven heat distribution caused by the presence of pipes embedded in the slab. This way, it is possible to take into account the pipe layout without maintaining a 2D thermal description.

- The variation of water temperature along the circuit is modelled considering the water circuit as a heat exchanger. The efficiency of such a heat exchanger is computed via the ϵ -NTU (effectiveness-Number of Transfer Units) method.

The consequent model transposes a 3D problem into a 1D R-C network, with a great advantage in computation time.

As a consequence, the average temperatures at the pipe, floor and ceiling surfaces are obtained. They are necessary in order to determine the heat flows exchanged between the water circuit and the room. Obviously, such an approach is aimed at energy analyses of radiant systems, whereas it might be limiting when a detailed description of the thermal profile on the floor and ceiling surfaces is needed. Such a detailed approach is anyway requested in few and particular research topics, and is over the requests of engineers and energy consultants.

METHODS

The connection between the hydronic circuit and the embedding structure

The achieved model results as an extension of the resistance method implemented in the new Standard EN 15377 and aimed at sizing thermo-active building systems.

The original model rises from studies by Glück (1982, 1989). In fact, Glück has found the analytical solution of the thermal field determined by the presence of pipes embedded in an infinitely long slab.

The following figure shows the thermal domain solved by Glück.

In particular, the main boundary conditions at the basis of this mathematical model are explained as follows:

- Steady state conditions
- Imposed heat transfer coefficients at the floor and ceiling surfaces
- Homogeneous slab
- Pipes are modelled via punctiform heat sources/sinks able to keep a fixed temperature at a distance equal to the pipe external radius

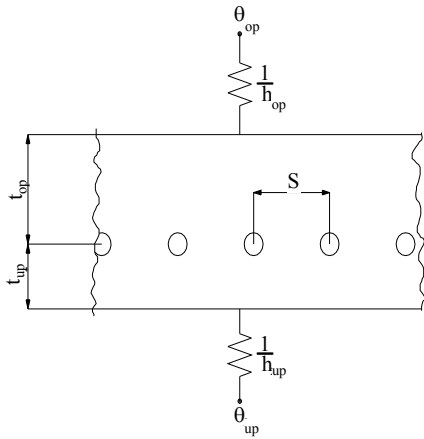

Figure 1 – Domain and boundary conditions for Glück's analytical solution

The consequent analytical solution is very complex, so it cannot be widely applied.

This analytical solution was however the basic starting point for the work of Dorer, Koschenz and Lehmann (2000, 2007). In fact, they continued the work by Glück and implemented the previous analytical solution into a simple method that describes the interaction between the hydronic circuit and the building structure via a thermal resistance network. One of the main concepts arising from this research consists in the definition of the pipe level thermal node. Basically this means that the action of the pipes is supposed to take place just at the plane where they lie. In this way, the 2D thermal field collapses into a 1D structure consisting of a sequence of thermal nodes, among which the thermal node representing the pipe level is included. This method was primarily aimed at sizing thermo-active systems in winter conditions. In more detail, the thermal resistances connect the supply water temperature and the pipe level temperature and are defined as follows:

- $$R_c = \frac{1}{2 \cdot \dot{m}_{sp} \cdot c_w}$$

is the thermal resistance describing the connection between the supply water temperature and the mean water temperature along the circuit.

- $$R_w = \frac{S^{0.13}}{8 \cdot \pi} \cdot \left(\frac{d_p - 2 \cdot t_p}{\dot{m}_{w,sp} \cdot \ell} \right)^{0.87}$$

is the thermal resistance due to the convective heat transfer from the water to the inner surface of the pipe.

- $$R_p = \frac{S \cdot \ln \left(\frac{d_p}{d_p - 2 \cdot t_p} \right)}{2 \cdot \pi \cdot \lambda_p}$$

is the thermal resistance related to the conduction heat transfer from the inner side of the pipe to the outer one.

- $$R_x = \frac{S \cdot \ln \left(\frac{S}{\pi \cdot d_p} \right)}{2 \cdot \pi \cdot \lambda_e}$$

is the thermal resistance connecting the temperature at the external side of the pipe with the temperature at the fictitious pipe level. It comes from the simplification of the Glück's equation, under the following geometrical conditions:

$$\begin{cases} \frac{t_{op}}{S} > 0.3 \\ \frac{t_{up}}{S} > 0.3 \\ \frac{d_p}{S} < 0.2 \end{cases}$$

In fact, under such hypotheses, the analytical solution by Glück can be efficaciously simplified.

As a consequence, such a model is still limited by the basic assumptions of the Glück model and moreover by the assumptions needed for its simplification. This way, the application of the method would be limited to radiant systems characterised by high thicknesses over and under the pipe level and by long pipe spacings.

Afterwards, the work of Dorer, Koschenz and Lehmann became the starting point for De Carli, Koschenz, Olesen and Scarpa (2006), who implemented the method within the new Standard EN 15377 for sizing thermo-active building systems. In the frame of that work, the accuracy of the method was evaluated in conditions different from the ones assumed for the development of the model. In particular, the model was tested under unsteady state boundary conditions and imposing heat flows at the floor and ceiling surfaces instead of heat transfer coefficients. At the end of that testing phase, the accuracy shown by the method was still good, but the above mentioned geometrical limits still held. As a consequence, in EN 15377 the method is applied to thermo-active building elements, even in summer conditions, even if the method was originally developed for steady state conditions.

As regards this aspect, the work presented in this paper can be considered as an extension of the EN 15377 project. In fact, within the frame of this work further tests were performed in order to verify the accuracy of the resistance method in unsteady state conditions, even for complex shape slabs. The tested slabs are presented in the following figures:

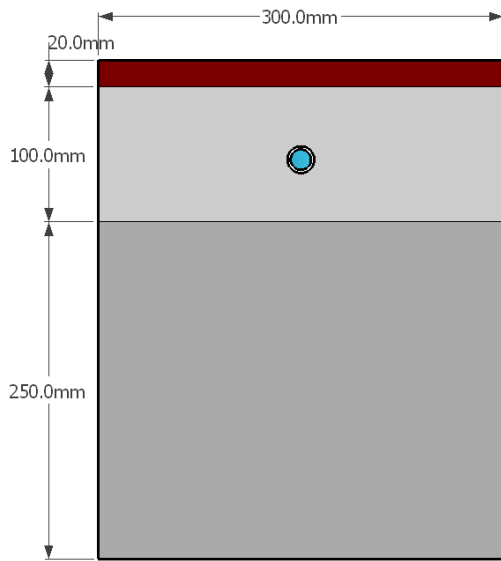

Figure 2 – Slab, type A

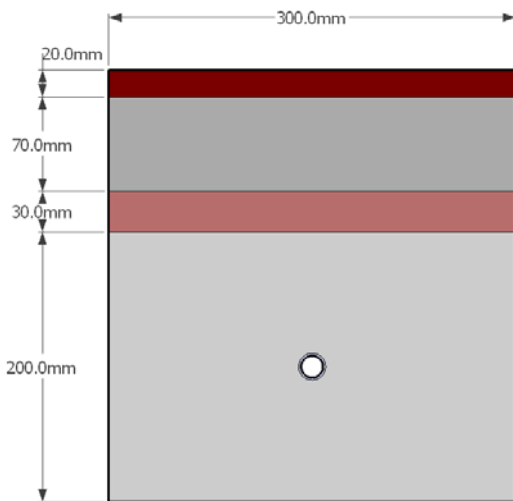

Figure 3 – Slab, type E

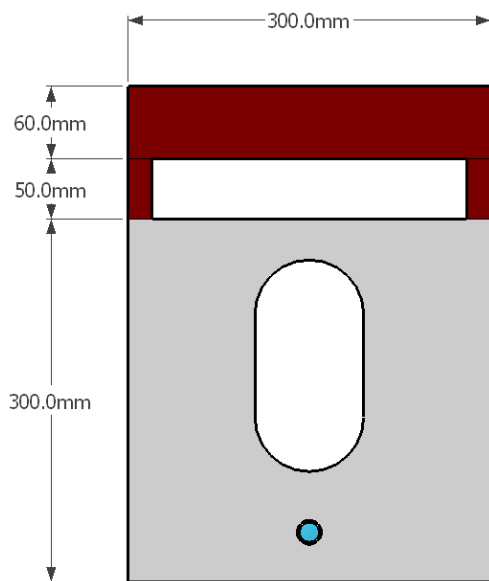

Figure 4 – Slab, type XI

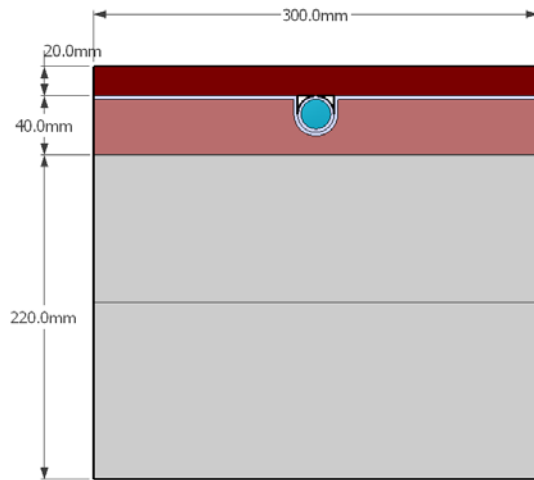

Figure 5 – Slab, type G

2D calculations have been contrasted against the 1D model by comparing the corresponding thermal behaviours along a period with imposed temperatures at the surfaces of the floor, ceiling and pipe. Figure 6 shows an example of temperature profiles used in the comparisons.

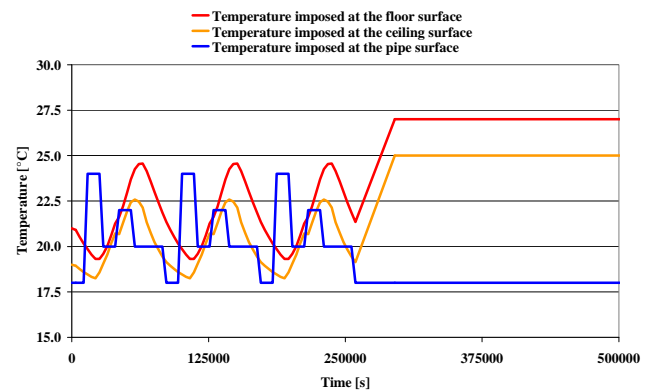

Figure 6 – Example of boundary conditions imposed for the validation of the 1D simplification of the thermal domain

The first part of the simulation period shows the difference of the thermal dynamic behaviour. Such a comparison is performed in terms of heat flows (through the floor, ceiling and pipe surfaces), temperatures (mean temperature at the pipe level, i.e. along the pipe spacing, but the diameter of the pipe), and perceived thermal resistance (between the temperature at the external side of the pipe and the mean temperature at the pipe level).

At the end of each simulation, constant boundary conditions were imposed in order to reach the steady state behaviour.

The thermal resistance R_x used in the 1D model is not calculated using the equation achieved by Dorer, Koschenz and Lehmann. In fact, in order to extend the method over the geometrical constraints imposed

by the resistance method, R_x is derived after a 2D simulation performed under steady state conditions. From the 2D simulation under steady state conditions, the heat flow passing through the pipe and the average temperature of the pipe level are used to calculate R_x using the equation:

$$R_x = \frac{\theta_{PL} - \theta_p}{S \cdot \dot{Q}_p}$$

R_x is placed at the pipe level and acts during the entire simulation period. Afterwards, heat flows and temperatures of the 1D model are compared with the 2D ones under the same boundary conditions. If they approach each other at the end, it means that the 2D model can be substituted by a 1D model where the thermal resistance acting between the pipe level and the external surface of the pipe is derived from a 2D model running under steady state conditions.

The analysis of the results focused on:

- the mean temperature at the pipe level
- the perceived thermal resistance between the external surface of the pipe and the pipe level
- the heat flows passing through the floor, the ceiling and the pipe.

Figure 7 shows an example of the comparisons, in terms of heat flows. The analysis of the simulations performed led to the assumption that a 1D simplification can be adopted in the description of each kind of slab simulated, since differences in heat flows perceived by the rooms and the circuit are really small, even during unsteady state conditions. In particular, the accuracy obtained in the forecast of heat flows through the pipe level is above the expectations, since the differences in the heat exchange by the circuit are always low, despite the important simplification that has been assumed, just in modelling the region where pipes are placed.

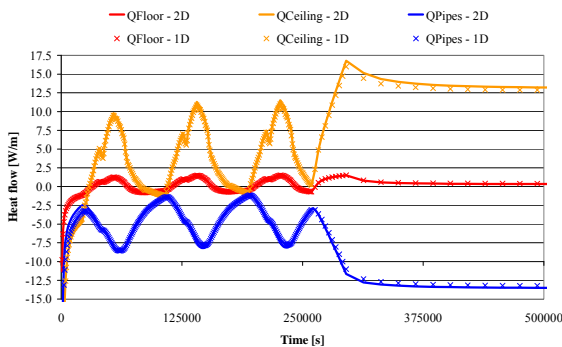

Figure 7 – Example of differences in heat flows implied by the 2D simplification

The comparisons in Figure 8 show the difference in the average temperature at the pipe level and in the “perceived” thermal resistance between the external surface of the pipes and the pipe level (R_x). In particular, the forecast of the average temperature of the pipe level is accurate, whereas the perceived

thermal resistance R_x suffered large variations during the simulation. Anyway, the largest variations in R_x happen when sudden increases/decreases in pipe temperature take place. Under such conditions, an inversion of heat flows is encountered. As a consequence, under these conditions, the large variation in the perceived thermal resistance R_x does not imply large variations in heat flows, since heat flows have low absolute values.

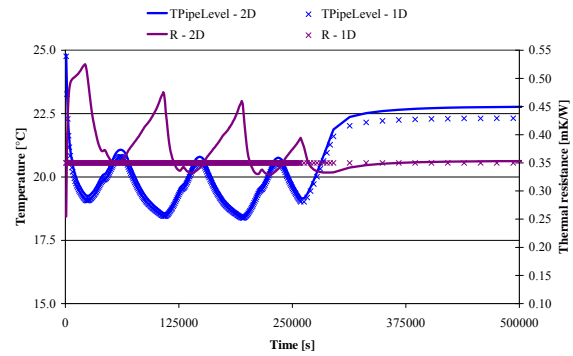

Figure 8 – Example of differences in pipe level temperature and perceived thermal resistance implied by the 2D simplification

The hydronic circuit as a heat exchanger

The hydronic circuit can be reduced to a heat exchanger in which the water exchanges heat with the thermal node at the pipe level. At this point, it is assumed that the pipe level is at uniform temperature. It is an assumption consistent with the formulation of energy simulation programs (assumption of 1D heat transfer through the surfaces) and is supported by the diffusivity of materials embedding the circuit, usually increased in order to get better performances by the radiant system.

In these conditions, the ε -NTU method is written in the following way:

$$\left\{ \begin{aligned} \varepsilon &= \frac{\dot{Q}}{\dot{Q}_{Max}} = \frac{\theta_w^{Out} - \theta_w^{In}}{\theta_{PL} - \theta_w^{In}} = 1 - e^{-(NTU)} \\ &\Downarrow \\ NTU &= \frac{U_c \cdot A_s}{(\dot{m} \cdot c)_{Min}} = \frac{U_c \cdot A_s}{\dot{m}_w \cdot c_w} \Rightarrow \varepsilon = 1 - e^{-\left(\frac{U_c \cdot A_s}{\dot{m}_w \cdot c_w}\right)} \end{aligned} \right.$$

where:

$$U_c = \frac{1}{R_w + R_p + R_x}$$

As a consequence, ε can be calculated through known parameters and hence the actual heat transfer can be calculated via the next equation:

$$\dot{Q} = \varepsilon \cdot \dot{Q}_{Max} = \varepsilon \cdot \dot{m}_w \cdot c_w \cdot (\theta_{PL} - \theta_w^{In})$$

Presentation of the calculation module

The input data to be entered by the user consist of data related to the building construction where pipes are going to be placed and of data related to the pipe and the circuit. Moreover, additional input data may be required, depending on the type of slab to be simulated.

Figure 9 shows the window dialog collecting the main input data for the description of the slab:

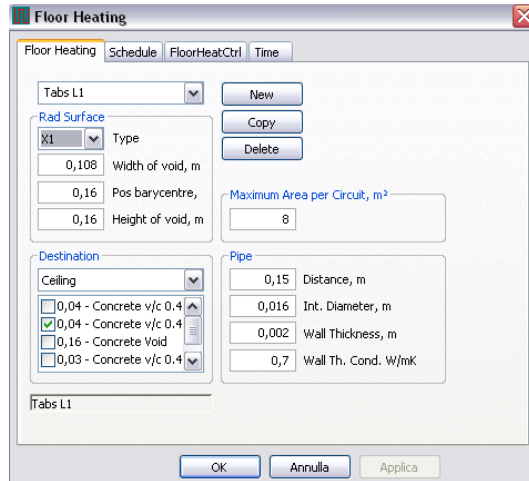

Figure 9 – Main window of the calculation module

Section “Destination” collects the data regarding the building construction where pipes are embedded, whereas section “Pipe” gets together the main data regarding the pipe and the circuit. With the parameter “Maximum Area per Circuit”, it is possible to create parallel circuits for the water. Moreover, additional data may be necessary for some types of slab.

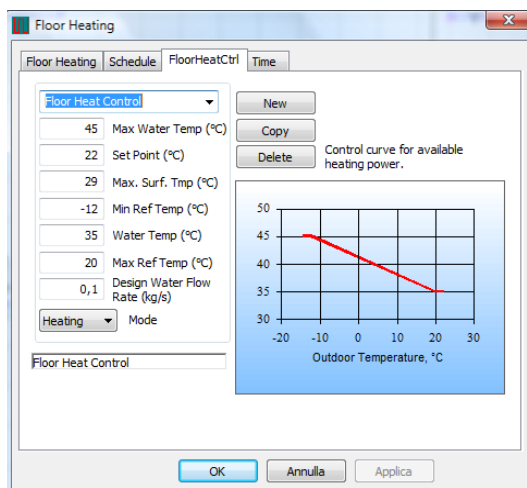

Figure 10 – Control window of the calculation module

At the present status, three kinds of controls are implemented in the module. In the following, such controls are described:

- Basic control (Figure 10): Such a control consists in a modulation based on outdoor temperature
- Control of the water supply temperature based on the outdoor and indoor operative temperatures, via the following equation (Olesen, 2004):

$$\theta_w = 0.52 \cdot (20. - \theta_{Ext}) + 20. - 1.6 \cdot (\theta_{Op} - 22.)$$

- Control of the water average temperature based on the outdoor and indoor operative temperatures, via the following equation (Olesen, 2004):

$$\bar{\theta}_w = 0.52 \cdot (20. - \theta_{Ext}) + 20. - 1.6 \cdot (\theta_{Op} - 22.)$$

Such a value is defined by considering the value of heat flow rate from/to the pipe to/from the pipe level during the previous time step:

$$\theta_w = 0.52 \cdot (20. - \theta_{Ext}) + 20. - 1.6 \cdot (\theta_{Op} - 22.) + \frac{\dot{Q}_{PL}}{2 \cdot \dot{m}_w \cdot c_{pw}}$$

EXPERIMENTAL APPARATUS

The facility used for the tests is located at the Civil Engineering Department of the Technical University of Denmark, Lyngby, and consists of a room provided with two levels of thermo-active components placed as floor and ceiling. The dimensions of the room are:

- Length: 6 m
- Width: 3.6 m
- Height: 3.6 m

The vertical walls are insulated and a guard box is placed around the room (Figure 11). This box encloses the room, so that it separates the room and the thermo-active components from the rest of the building, in order to prevent that the external environment influences the system. Moreover, the air temperature inside the guard is controlled by a PID device that forces the air temperature to follow the test room air temperature. Inside the guard, two fans are placed to mix the air and to avoid temperature stratification.

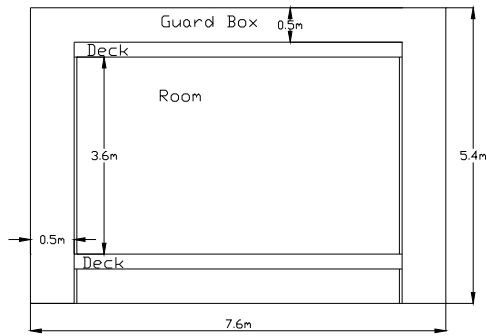

Figure 11 – Sketch of the test facility

Floor and ceiling both consist in three prefabricated hollow-core concrete decks with pipes embedded in the concrete. Each deck is 6.6 m long, 1.2 m wide and 0.27 m high (Figure 12). The sizes of cavities are 150x108 mm at the highest and at the widest spots. The distance between the vertical axes of symmetry is 150 mm.

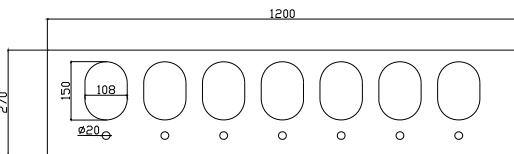

Figure 12 – Sketch of the active slab present in the test facility

The thermo-active components have integrated PEX pipes placed below each cavity. The pipe level is 50 mm above the ceiling surface of the deck. The diameters of the pipes are: inner diameter 16 mm, outer diameter 20 mm.

RESULTS

Tests have been performed in order to check the calculation module developed.

Steady state as well as unsteady state tests were carried out.

Steady state tests were useful for checking the 2D simplification on the thermal domain, together with the application of the ϵ -NTU approach. In a few words, the possibility of avoiding phenomena related to the thermal capacity of the room makes it possible to focus solely on the circuit.

When unsteady state measurements are considered instead, even dynamic phenomena can be considered. Figure 13 and Figure 14 show the main temperatures obtained by measurements and simulations, whereas Figure 15 and Figure 16 show differences in heat extracted by the cooling unit.

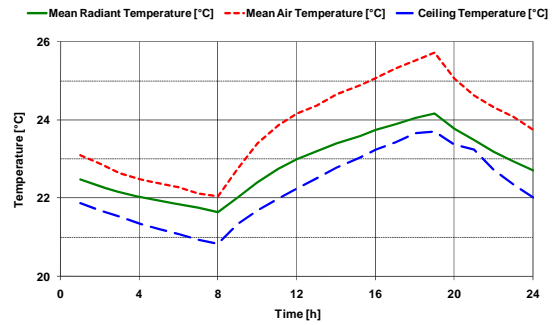

Figure 13 – Main temperatures obtained from measurements under unsteady state conditions

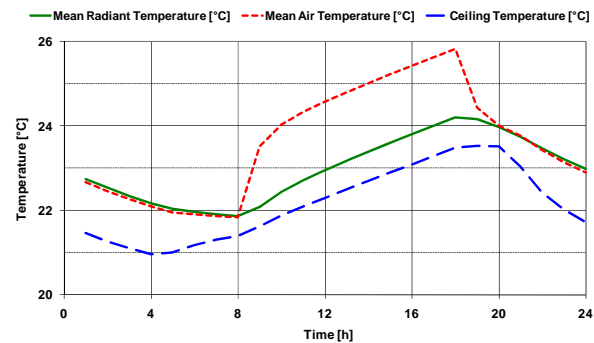

Figure 14 – Results obtained by the calculation module under unsteady state conditions

The results presented refer to the following operating conditions:

- Heat loads: 5 W/m² from 08:00 to 18:00
- System
 - On from 20:00 to 08:00
 - Supply water temperature: 19°C
 - Setpoint in air temperature: 21°C

To summarise, the regulation is similar to the one used in thermo-active building systems: the slab is cooled down during the night, so it is prepared to absorb heat from the room when heat loads take place.

From the comparison of temperature profiles, the trends of temperatures in the test room looks well described. As a matter of fact, maximum and minimum temperatures correspond and the temperature trends are similar. Some differences, anyway may be encountered. In particular, the simulation tool looks to underestimate the thermal inertia of air. Especially, that could depend on the additional thermal inertia present in the room, due to desks and appliances used to simulate office heat loads in the test facility. Thus the air temperature in the simulation quickly loses internal energy and assumes the same temperature value as the surfaces,

when no heat loads are present. So the air temperature cools down quickly and reaches the set-point temperature earlier than in the reality. That is considered to be one of the main causes of the different shapes of the cooling rate profile, which are shown in *Figure 15* and in *Figure 16*. In fact, the simulation tool imposes the circuit to switch off earlier than in the test room. But further notes may be derived via the analysis of cooling rate trends. For instance, the simulation tool looks to overestimate the action of the system. In fact, the system always extracts more heat than the real circuit. Anyway, such a difference can be ascribed even to the values of the thermal properties estimated in the calculation tool, and to an improvable distribution of radiant and convective heat loads. Moreover, even the values of the real convective heat transfer coefficients may be different from the ones assumed in the simulation tool, so more accuracy in the forecast of the heat exchange between the test room and the slab might be acquired via a better estimation of the convective heat transfer coefficients characteristic of the simulated room.

To summarise, despite of these discrepancies due to the incomplete knowledge of the room characteristics and heat load distributions, the simulation tool shows consistent results and allows the user to forecast temperatures and heat loads in an accurate way.

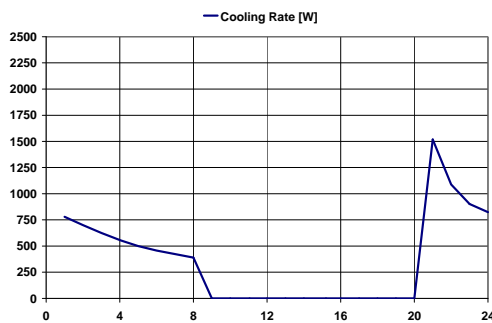

Figure 15 – Cooling rate from measurements under unsteady state conditions

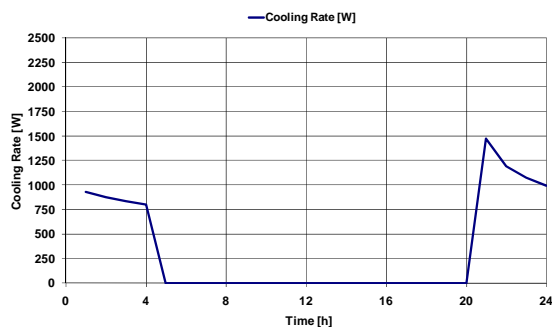

Figure 16 – Cooling rate from simulation under unsteady state conditions

CONCLUSION

In the present project, the accuracy achievable by important simplifications in the description of radiant systems has been studied. After this numerical part, a simulation tool has been developed and integrated within software BSim. The whole software has been contrasted against measurements performed in an appropriate test facility. The simulation tool shows consistent results, improvable via a better knowledge of the thermal characteristics of the simulated room, and accurate enough for use in energy simulations.

REFERENCES

- Glück, B., 1982. Strahlungsheizung – Theorie und Praxis, Verlag C.F. Müller, Karlsruhe.
- Glück, B., 1989. Wärmeübertragung, Wärmeabgabe von Raumheizflächen und Rohren, VEB Verlag für Bauwesen. Berlin.
- Koschenz, M., Lehmann, B., 2000. Thermoaktive Bauteilsysteme, EMPA, Dübendorf (CH).
- Lehmann, B., Dorer, V., and Koschenz, M., 2007. Application range of thermally activated buildingsystems tabs, Energy and Buildings, Volume 39, Issue 5, May 2007, Pages 593-598.
- De Carli, M., Koschenz, M., Olesen, B.W., Scarpa, M., 2006. Dynamic Evaluation of the Cooling Capacity of Thermo Active Building Systems, ASHRAE 2006 WINTER MEETING - Chicago, IL, January 2006.
- CEN, Standard EN 15377 - Heating systems in buildings - Design of embedded water based surface heating and cooling systems.
- Olesen, B.W., Currò Dossi F., 2004. Operation and Control of Activated Slab Heating and Cooling Systems, Proceedings of CIB World Buildings Congress 2004, 2004, Toronto, Canada.

NOMENCLATURE

Magnitudes

A : Area [m^2]

c : Specific heat capacity [$\frac{J}{kg \cdot K}$]

d : Diameter [m]

\dot{m} : Flow [$\frac{kg}{s}$]

ℓ : Circuit length [m]

NTU: Number of Transfer Units [-]

\dot{q} : Specific heat flow [$\frac{W}{m^2}$]

\dot{Q} : Heat flow [W]

S : Pipe spacing [m]

t : Thickness [m]

U : Global heat transfer coefficient $\left[\frac{W}{m^2} \right]$

ε : Heat exchange efficiency [-]

θ : Temperature [$^{\circ}C$]

λ Thermal conductivity $\left[\frac{W}{m \cdot K} \right]$

Subscripts

c : refers to the circuit

e : refers to the material embedding the pipes

Ext : refers to the exterior environment

Max : maximum

Min : minimum

op : refers to the part of the slab placed on the pipe level

Op : operative

p : refers to the pipe

PL : refers to the pipe level

sp : refers to 1 m² of floor area

up : refers to the part of the slab placed under the pipe level

w : refers to the water

Superscripts

In : refers to the inlet side of the circuit

Out : refers to the outlet side of the circuit