

WHOLE YEAR SIMULATION OF HUMIDITY BASED DEMAND CONTROLLED HYBRID VENTILATION IN MULTIAPARTMENT BUILDING

Jerzy Sowa^{*}, Maciej Mijakowski

*Warsaw University of Technology
Faculty of Environmental Engineering
Nowowiejska 20
00-653 Warsaw, Poland*

**Corresponding author: jerzy.sowa@is.pw.edu.pl*

ABSTRACT

The paper presents the whole year simulation of humidity based demand controlled hybrid ventilation in multiapartment building. The simulation was performed for NAPE (National Energy Conservation Agency) multifamily residential reference building. This allowed the authors to compare obtained results with earlier investigated behaviour of the NAPE building with passive stack ventilation and mechanical exhaust ventilation. Simulations were performed using computer programme CONTAM (developed by NIST). In CONTAM environment the building together with analysed ventilation system has been idealized as 127 zones and 884 flow paths. Simulations were performed with 5 min time step (results were stored with 1 h time step). Huge set of results allow the authors to compare behaviour of the analysed ventilation systems depending on the number of storey, size of the apartment, type of space etc. CONTAM does not allow users to perform thermal analysis of the buildings, but thermal and energetic analyses can be performed separately at second step (using airflows calculated by CONTAM). The 6RIC model developed at Warsaw University of Technology was used for this purpose.

Performed simulations presented the possibilities of utilisation computer programme CONTAM for modelling behaviour of humid air in buildings, even when they are huge and complex. Additionally obtained results indicated once again that humidity based demand controlled hybrid ventilation systems can reduce substantially amount of energy in residential buildings.

KEYWORDS

Simulation, CONTAM, Demand controlled ventilation

INTRODUCTION

Humidity based demand controlled hybrid ventilation systems create many problems during modelling. If the system is analyzed in residential or office building with many rooms, the applied model has to allow researcher to perform multizone simulations. Hybrid nature of the system causes that natural as well as mechanical forces driving airflows have to be taken into account. Utilisation of humidity based demand controlled strategies calls for simultaneous calculations of humidity ratio in each of the building zone and calculations of airflows between zones. Moreover software used for simulations has to allow users to model control elements.

The paper presents the whole year simulation of humidity based demand controlled hybrid ventilation in multiapartment building. The simulation were performed for NAPE (National Energy Conservation Agency) multifamily residential reference building. This allowed the

authors to compare obtained results with earlier investigated behaviour of the NAPE building with passive stack ventilation and mechanical exhaust ventilation.

The simulations were performed in two steps. Airflows were analysed using CONTAM with 5 min time step (results were stored with 1 h time step) while energetic assessments were performed using 6R1C model (hourly calculations).

ANALYSED BUILDING

The National Energy Conservation Agency NAPE reference building is a virtual, residential building with 8 storeys. The building has the total volume of $V_e = 5865 \text{ m}^3$, surface of envelope $A_e=2028.5 \text{ m}^2$ (shape ratio $A_e/V_e = 0.35$) and usable area $A_f = 1634 \text{ m}^2$. All assumed parameters (e.g. size of windows, thermal resistances of walls etc.) fulfil minimum requirements for new buildings described in Polish building codes and related ministerial ordinances.

There are 3 different small flats at each storey with 1, 2 and 3 rooms respectively (fig. 1). Altogether there are 23 flats, occupied by 47 persons.

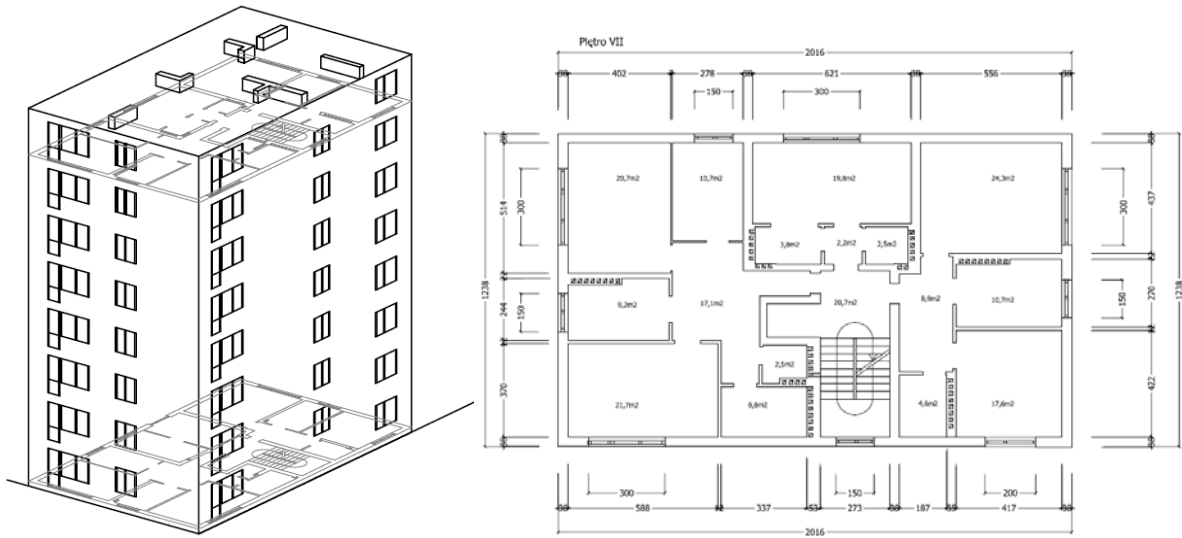

Figure 1. The NAPE reference building - view and plan of the typical storey.

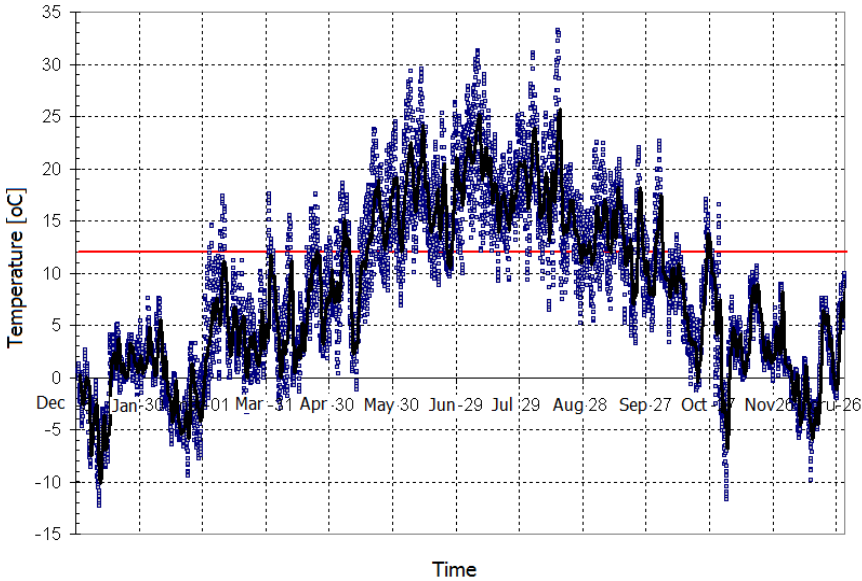

Figure 2. Ambient temperature for Warsaw- dots hourly data, black line daily average.

The building is virtually located in Warsaw. Any airflow or energetic calculations for this building are performed using typical meteorological year published by the Polish Ministry of Infrastructure http://www.mi.gov.pl/2-48203f1e24e2f-1787735-p_1.htm. This file has been prepared according to EN ISO 15927-4, [1]. According to these data in Warsaw ambient temperature varies from -12 °C to +34 °C, while span of daily average temperature is -7 °C to +24 °C (fig. 2).

The NAPE reference building is equipped with 2 optional systems of ventilation. Option 1 is passive stack ventilation. Exhaust grills connected to individual stacks with cross-section 14x14 cm are located in kitchens, bathrooms, toilets. Air is supplied to the flats through air vents installed in each window. In test conditions at 10 Pa pressure difference these vents should provide 50 m³/h [4].

Option 2 is mechanical exhaust ventilation that meets minimal requirements of Polish standards. Air is exhausted from kitchens (70 m³/h for kitchens equipped with gas cooker), bathrooms with or without toilet (50 m³/h) and separate toilets (30 m³/h) [4]. Air supply is through air vents which in case of mechanical exhaust ventilation provides 30 m³/h of air when tested with 10 Pa pressure difference [4].

In this study the building was equipped with humidity based demand controlled hybrid ventilation. Air vents used in that system has variable characteristics influenced by relative humidity. For given pressure drop air flow is proportional to relative humidity (in range 30÷70 %). Characteristics of exhaust grills also depend on relative humidity. Additionally exhaust grills mounted in bathrooms and toilets are equipped with presence sensors that force opening of a control damper when users are in a space (delay for switching off is 20 min). Exhaust fans mounted on a roof above collecting ducts are equipped with pressure sensors and can reduce fan speed when needed.

AIRFLOW SIMULATIONS

Air flow simulations were performed using well known and verified computer programme CONTAM (developed by NIST [5]). In CONTAM environment the building together with analysed ventilation system has been idealized as 127 zones and 884 flow paths. Additionally in case of humidity based demand controlled hybrid ventilation systems the model takes into account controls (in analysed case humidity influences characteristics of air vents, exhaust grills and exhaust fans). It should be pointed out that real control network is more complex than presented on a sketchpad as some nodes can be so called superelements that in fact are control subnetworks.

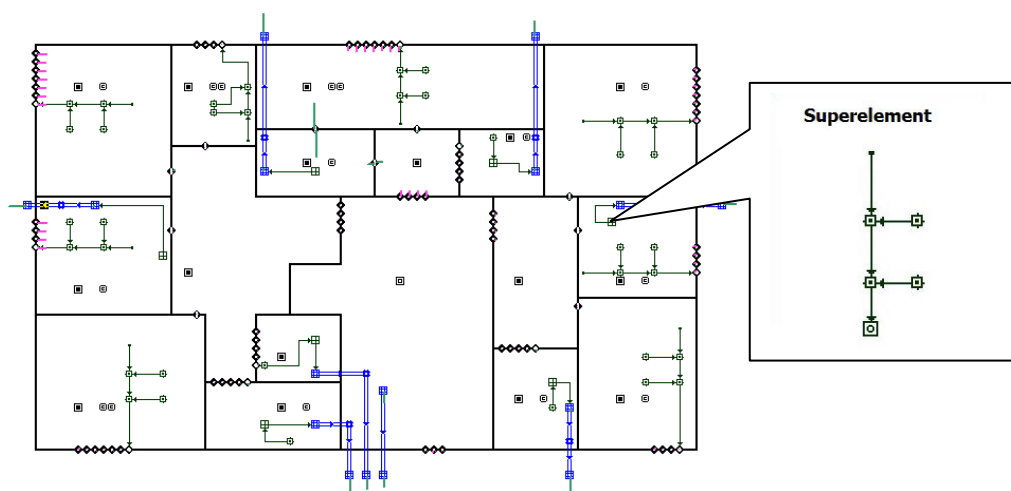
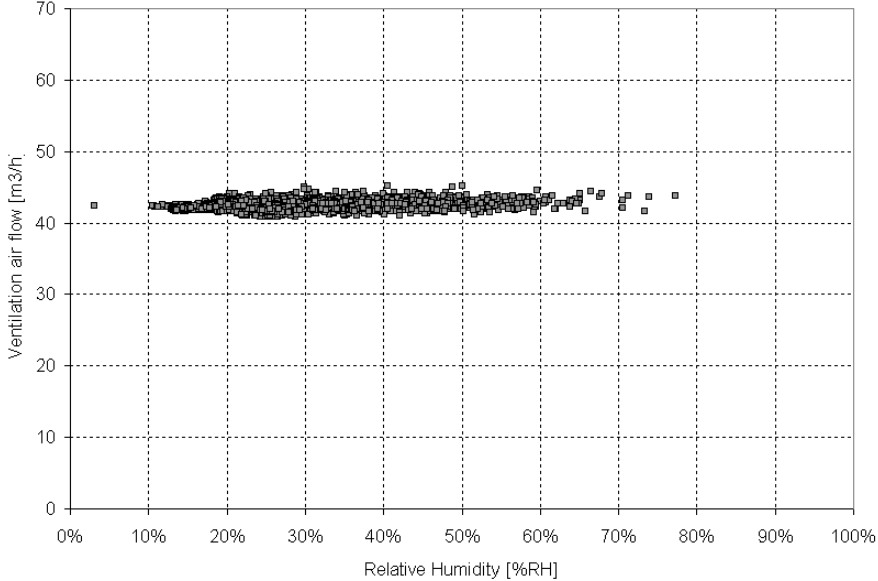

Fig. 3. Sketchpad (CONTAM) presenting 8 floor of analyzed building for analyzed variant.

Figure 4 presents the difference between performance of exhaust grill (example: kitchen in M3 flat at 8 floor) used in regular mechanical exhaust ventilation and grill used in humidity based demand controlled ventilation. One may observe that in case of very high relative humidity analysed demand controlled system is able to ventilate moist space more effectively.

a) Mechanical exhaust ventilation



b) Humidity based demand controlled ventilation

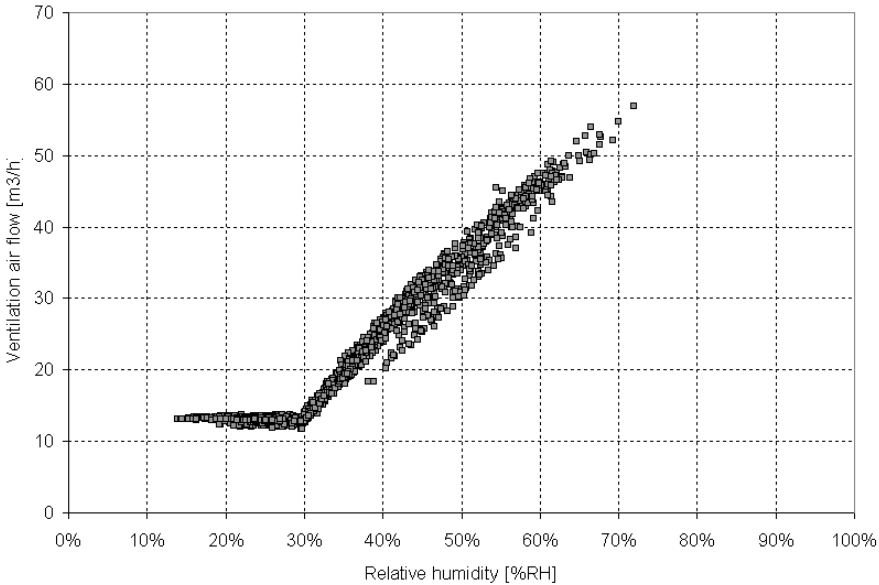
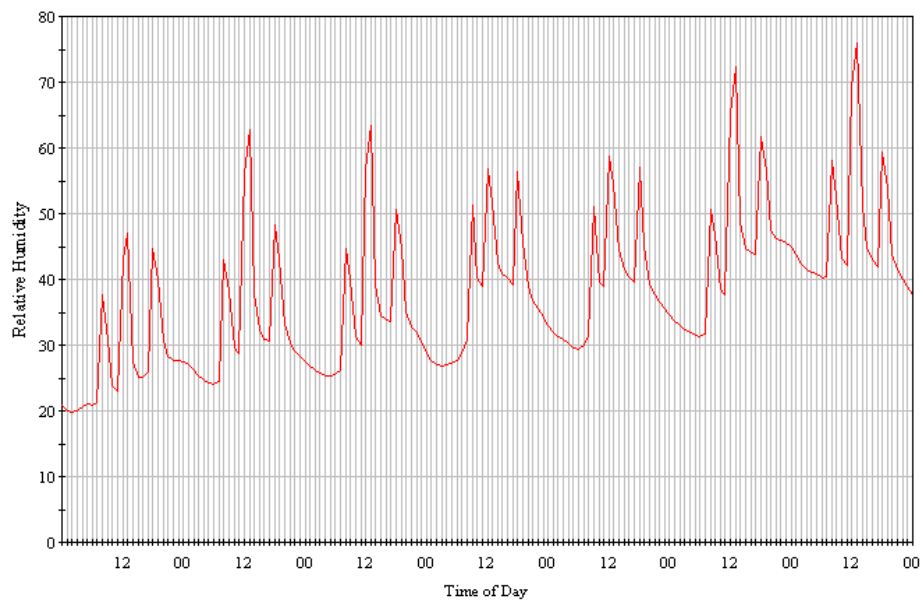

Figure 4. Airflow through exhaust grill in analyzed kitchen M3 8 floor as a function of relative humidity of air (January 1st – March 31st).

As a result of this phenomena humidity ratio and relative humidity differs between analysed systems. Figure 5 presents relative humidity in the same space as above for two variants: regular mechanical exhaust ventilation a), and humidity based demand controlled ventilation b). One may observe that due to better performance of exhaust grill, relative humidity peaks are lower in case of demand controlled ventilation.

b) Mechanical exhaust ventilation



b) Humidity based demand controlled ventilation

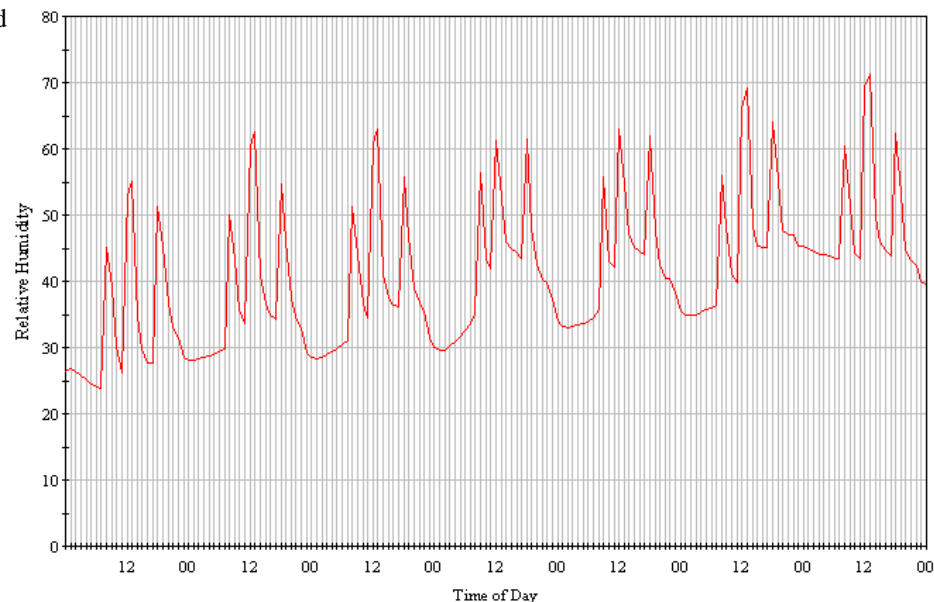

Figure 5. Relative humidity in kitchen on last floor in M3 dwelling during one week in March for variant 1 (a) and 2 (b).

As during summer buildings are not heated and users strongly change their behavior related to opening windows the calculations were performed only for heating season. It has been assumed that heating season starts in autumn when the daily average temperature drops below +12 °C and the heating period stops when daily average temperature exceeds +12 °C at spring. Meteorological data corrected in such a way gives for Warsaw 3855 degreedays that is in good agreement with commonly used in simplified methods value 3885 degreedays.

As CONTAM [5] does not allow users to perform thermal analysis of the buildings, thermal and energetic analyses were performed separately at second step (using airflows calculated by CONTAM at first step). Energetic aspects were analysed using lumped capacitance building 6R1C heat exchange model (developed at Warsaw University of Technology, [3]). The model is the further development of simple hourly method described in ISO FDIS 13790:2007, [2]. The most important modification is related to splitting air flows between outdoor and indoor into controlled airflow (with known or calculated supply temperature) and uncontrolled infiltration/exfiltration. The model, similarly as 5R1C, allows supplying the heat energy to three nodes – to interior of building construction, to the internal surface of building

construction and to indoor air. Developed model has been successfully verified with the BESTEST [3].

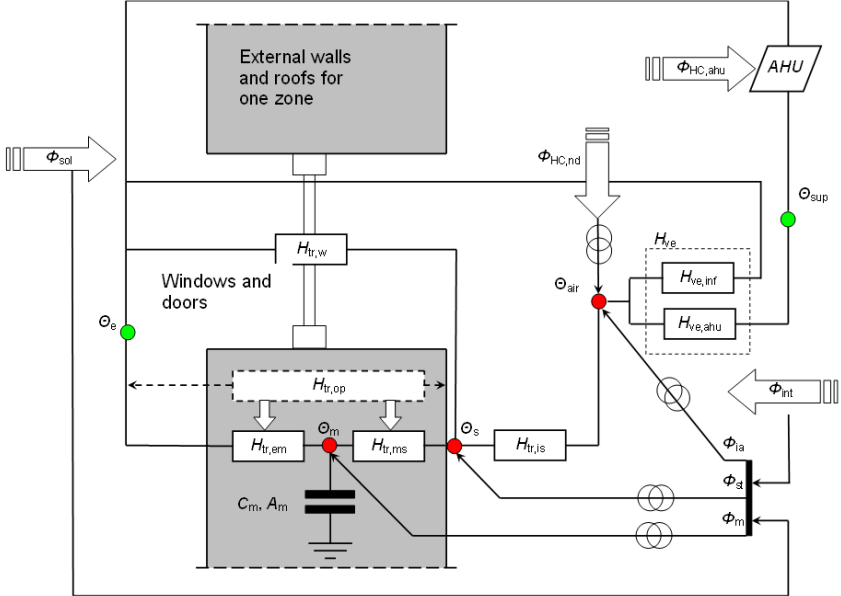

Figure 6. Lumped capacitance building 6R1C heat exchange model

RESULTS

Detailed simulations provided huge set of results that allowed the authors to compare behaviour of the analysed ventilation systems for whole building, as well as for different flats located at different storey.

Figure 7 presents ventilation rate for whole building during the heating period in case of humidity based demand controlled hybrid ventilation. It should be pointed out that obtained ventilation rates are much below values required by Polish Standard PN-82/B-03430/Az3:2000 [4] and commonly used rough indicator equal 1 air change rate per hour.

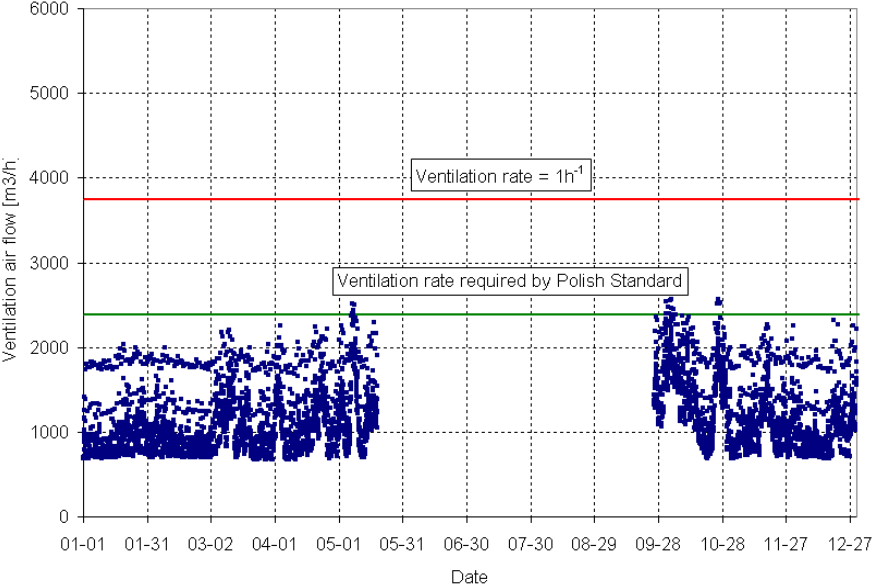

Figure. 7. Ventilation rate for whole building during the heating period for humidity based demand controlled hybrid ventilation.

Table 1 presents comparison of air ventilation rates for different flats and different storey. Simulation indicated that humidity based DCV system works with substantial differences in ventilation rate over time but without important differences between storey. Average air volume is ~ 40 % of maximum value that is approximately equal required ventilation rate.

The mechanical exhaust ventilation (table 2) works very stable over time and also without differences between flats. Performance of passive stack ventilation presented in table 3 shows that there are huge differences in ventilation rate not only over time but also between similar flats located at different storey. Maximum values 2-times exceed requires ventilation rates.

	Ventilation rate. m ³ /h						
	Total	Flat M1 8 storey	Flat M2 8 storey	Flat M3 8 storey	Flat M1 2 storey	Flat M2 1 storey	Flat M3 1 storey
Average	1133	38	36	66	39	37	67
Minimum	667	24	21	34	25	22	36
Maximum	2566	102	90	151	102	90	148
Standard deviation	402.4	14.5	14.7	25.5	14.9	14.9	25.6

Table 1. Summary of airflows analysis for humidity based demand controlled ventilation.

	Ventilation rate. m ³ /h						
	Total	Flat M1 8 storey	Flat M2 8 storey	Flat M3 8 storey	Flat M1 2 storey	Flat M2 1 storey	Flat M3 1 storey
Average	2160	87	68	112	91	75	120
Minimum	2069	83	65	107	87	68	110
Maximum	2314	101	78	122	102	86	130
Standard deviation	37.2	1.5	1.6	1.9	2.1	2.7	3.5

Table 2. Summary of airflows analysis for mechanical exhaust ventilation.

	Ventilation rate. m ³ /h						
	Total	Flat M1 8 storey	Flat M2 8 storey	Flat M3 8 storey	Flat M1 2 storey	Flat M2 1 storey	Flat M3 1 storey
Average	3253	54	88	119	120	167	230
Minimum	1086	3	28	32	45	41	48
Maximum	5590	261	289	360	243	270	349
Standard deviation	615.8	29.1	36.1	45.7	24.6	30.3	41.9

Table 3. Summary of airflows analysis for passive stack ventilation.

These differences influences also energy performance of the whole building. The primary energy use for heating and ventilation (mechanical exhaust system), calculated using reference climatic data for Warsaw and heating system efficiency 0.9 and primary energy conversion factors 0,8 for heat (produced in cogeneration) and 3,0 for electricity is 106 681 kWh/year (65.29 kWh/(m²year)).

Application of the humidity based demand controlled hybrid ventilation system reduces primary energy use by ~25% to 79 712 kWh/year (48.78 kWh/(m²year)).

Benefits are even more obvious when comparing this system with passive stack ventilation which has primary energy use 132889 kWh/year (81,33 kWh/(m²year)). In such a comparison benefits resulting from application demand controlled hybrid ventilation may reach 40% of primary energy use.

CONCLUSION

Performed simulations presented the possibilities of utilisation computer programme CONTAM for modelling behaviour of humid air in buildings, even when they are huge and complex and building systems contains control elements. Additionally obtained results indicate once again that humidity based demand controlled hybrid ventilation systems can reduce substantially amount of energy in residential buildings.

REFERENCES

- [1] EN ISO 15927-4:2007 – *Hygrothermal performance of buildings -- Calculation and presentation of climatic data -- Part 4: Hourly data for assessing the annual energy use for heating and cooling*
- [2] ISO-FDIS 13790:2007 *Energy performance of buildings - Calculation of energy use for space heating and cooling.*
- [3] Narowski P., Mijakowski M., Panek A.D., Rucińska J., Sowa J., *Integrated 6RIC Energy Simulation Method – Principles, Verification And Application*, Preceedings of the 10th Rehva World Congress “Sustainable Energy Use in Buildings” CLIMA 2010, May 9-12 2010, Antalya, Turkey
- [4] PN-83/B-03430/Az3:2000, *Ventilation in dwelling and public utility buildings Specifications (in Polish)*
- [5] Walton G.N., Dols S.W., *CONTAM – User Guide and Program Documentation*, NISTIR 7251, October 2005